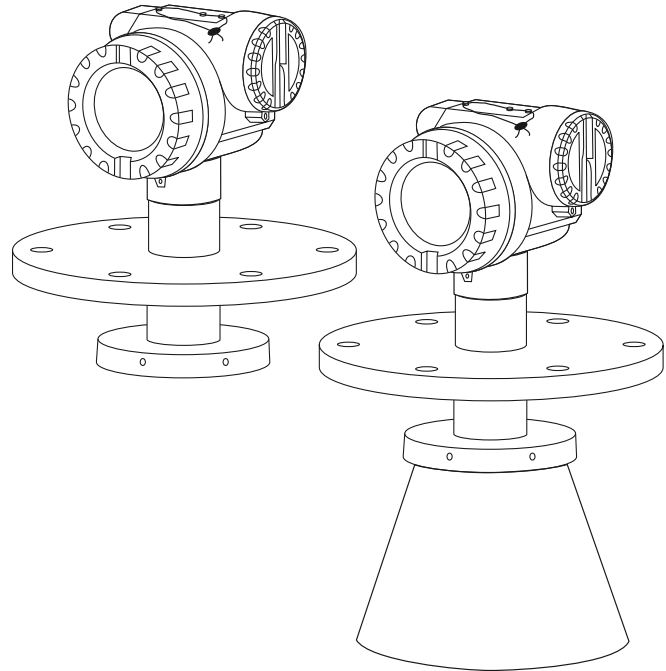


7532 Radar Tank Gauge

Smart transmitter for continuous and non-contact precision level measurement. For custody transfer and inventory-control applications with NMI and PTB approval.

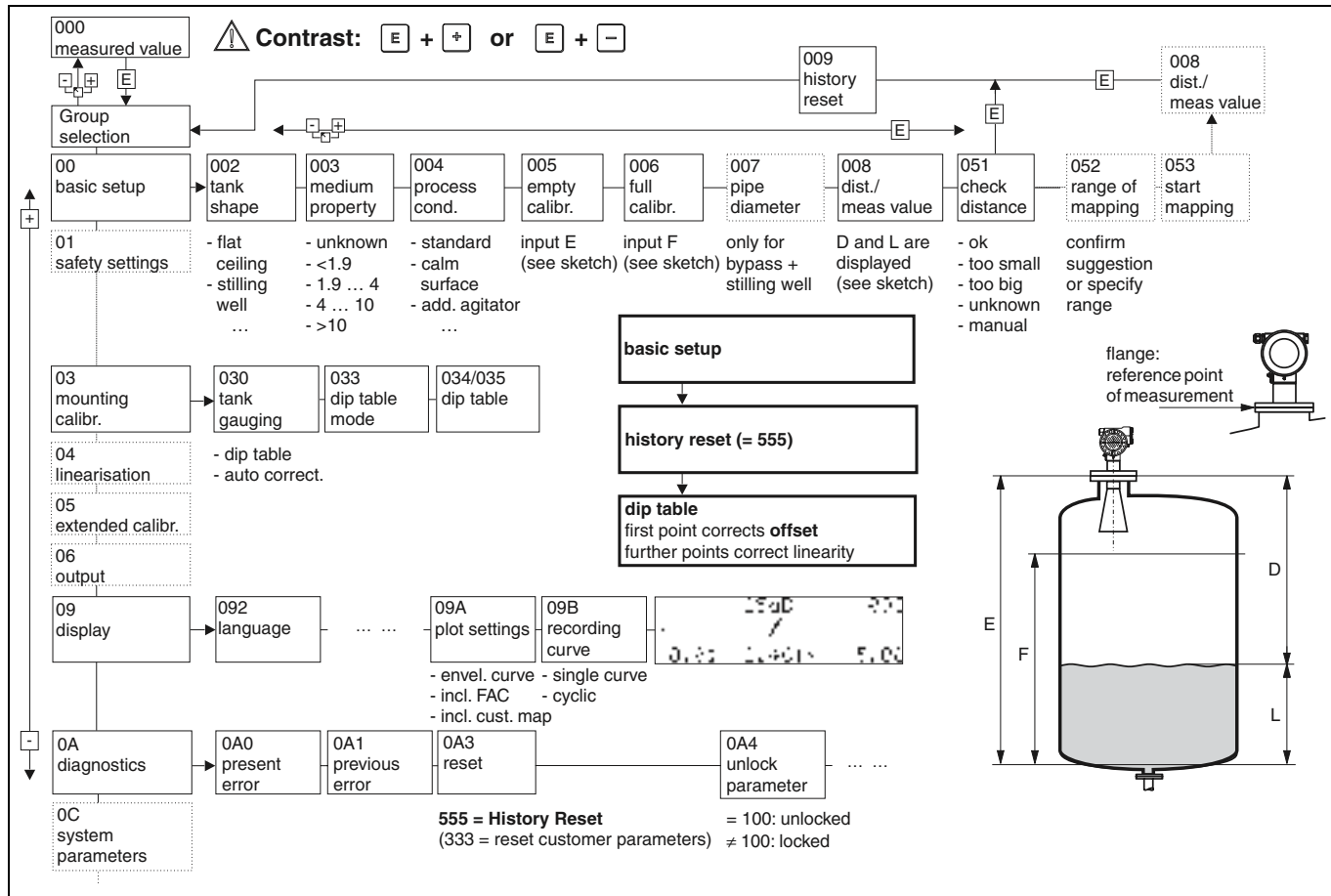
Varec[®]

Installation and Operations Manual



www.varec.com

Brief operating instructions



Note!

This operating manual explains the installation and initial start-up for the level transmitter measuring device. All functions that are required for a typical measuring task are taken into account here. In addition, the 7532 RTG provides many other functions that are not included in this operating manual, such as optimizing the measuring point and converting the measured values.

An overview of all device functions can be found on page 96.

A description of the device functions for the 7532 RTG can also be found on the enclosed CD-ROM.

Table of Contents

1	Safety Instructions	4	6	Commissioning	45
1.1	Designated use	4	6.1	Function check	45
1.2	Installation, commissioning and operation	4	6.2	Commissioning	45
1.3	Operational safety	4	6.3	Basic Setup	46
1.4	Return	5	6.4	Basic Setup with the VU 331	49
1.5	Notes on safety conventions and symbols	6	6.5	Mounting calibration with VU 331	57
2	Identification	7	6.6	Basic Setup with the ToF Tool	66
2.1	Device designation	7	6.7	Mounting calibration with the ToF Tool	70
2.2	Scope of delivery	10	7	Maintenance	73
2.3	Certificates and approvals	10	8	Accessories	75
2.4	Registered trademarks	10	9	Troubleshooting	77
3	Mounting	11	9.1	Troubleshooting instructions	77
3.1	Quick installation guide	11	9.2	System error messages	79
3.2	Incoming acceptance, transport, storage	12	9.3	Application errors	81
3.3	Installation Conditions	13	9.4	Spare parts	83
3.4	Installation instructions	17	9.5	Return	86
3.5	Post-installation check	24	9.6	Disposal	86
4	Wiring	25	9.7	Software history	86
4.1	Quick wiring guide	25	10	Technical data	87
4.2	Connecting the measuring unit	28	10.1	Technical data at a glance	87
4.3	Equipotential bonding	30	11	Appendix	91
4.4	Degree of protection	30	11.1	Operating menu HART (Display modul), ToF Tool 91	
4.5	Overvoltage protector	30	11.2	Operating matrix HART / Commuwin II	94
4.6	Post-connection check	30	11.3	Description of functions	96
5	Operation	31	11.4	Function and system design	97
5.1	Quick operation guide	31	Index		103
5.2	Display and operating elements	34			
5.3	Local operation	37			
5.4	Display and acknowledging error messages	40			
5.5	HART communication	41			

1 Safety Instructions

1.1 Designated use

The Varec Model 7532 Radar Tank Gauge (RTG) is a compact radar level transmitter for the continuous, contactless measurement of liquids, pastes and sludge in stilling wells. The device can also be freely mounted outside closed metal vessels because of its operating frequency of about 6 GHz and a maximum radiated pulsed energy of 1 mW (average power output 1 μ W). Operation is completely harmless to humans and animals.

1.2 Installation, commissioning and operation

The 7532 RTG has been designed to operate safely in accordance with current technical, safety and EU standards. If installed incorrectly or used for applications for which it is not intended, however, it is possible that application-related dangers may arise, e.g. product overflow due to incorrect installation or calibration. For this reason, the instrument must be installed, connected, operated and maintained according to the instructions in this manual: personnel must be authorised and suitably qualified. The manual must have been read and understood, and the instructions followed. Modifications and repairs to the device are permissible only when they are expressly approved in the manual.

1.3 Operational safety

Hazardous areas

Measuring systems for use in hazardous environments are accompanied by separate “Ex documentation”, which is an *integral part* of this Operating Manual. Strict compliance with the installation instructions and ratings as stated in this supplementary documentation is mandatory.

- Ensure that all personnel are suitably qualified.
- Observe the specifications in the certificate as well as national and local regulations.

FCC-approval

This device complies with part 15 of the FCC Rules. Operation is subject to the following two conditions: (1) This device may not cause harmful interference, and (2) this device must accept any interference received, including interference that may cause undesired operation.

Caution!

Changes or modifications not expressly approved by the part responsible for compliance could void the user’s authority to operate the equipment.

1.4 Return

The following procedures must be carried out before a transmitter is sent to Varec for repair:

- Always enclose a duly completed "Declaration of contamination" form. Only then can Varec transport, examine and repair a returned device.
- Enclose special handling instructions if necessary, for example a safety data sheet as per EN 91/155/EEC.
- Remove all residue which may be present. Pay special attention to the gasket grooves and crevices where fluid may be present. This is especially important if the fluid is dangerous to health, e.g. corrosive, poisonous, carcinogenic, radioactive, etc.

Caution!

- No instrument should be sent back for repair without all dangerous material being completely removed first, e.g. in scratches or diffused through plastic.
- Incomplete cleaning of the instrument may result in waste disposal or cause harm to personnel (burns, etc.). Any costs arising from this will be charged to the operator of the instrument.

1.5 Notes on safety conventions and symbols

In order to highlight safety-relevant or alternative operating procedures in the manual, the following conventions have been used, each indicated by a corresponding symbol in the margin.






Safety conventions

Symbol	Meaning
Warning!	A warning highlights actions or procedures which, if not performed correctly, will lead to personal injury, a safety hazard or destruction of the instrument
Caution!	Caution highlights actions or procedures which, if not performed correctly, may lead to personal injury or incorrect functioning of the instrument
Note!	A note highlights actions or procedures which, if not performed correctly, may indirectly affect operation or may lead to an instrument response which is not planned

Explosion protection

	Device certified for use in explosion hazardous area If the 7532 RTG has this symbol embossed on its name plate it can be installed in an explosion hazardous area
	Explosion hazardous area Symbol used in drawings to indicate explosion hazardous areas. – Devices located in and wiring entering areas with the designation "explosion hazardous areas" must conform with the stated type of protection
	Safe area (non-explosion hazardous area) Symbol used in drawings to indicate, if necessary, non-explosion hazardous areas. – Devices located in safe areas still require a certificate if their outputs run into explosion hazardous areas.

Electrical symbols

	Direct voltage A terminal to which or from which a direct current or voltage may be applied or supplied
	Alternating voltage A terminal to which or from which an alternating (sine-wave) current or voltage may be applied or supplied
	Grounded terminal A grounded terminal, which as far as the operator is concerned, is already grounded by means of an earth grounding system
	Protective grounding (earth) terminal A terminal which must be connected to earth ground prior to making any other connection to the equipment
	Equipotential connection (earth bonding) A connection made to the plant grounding system which may be of type e.g. neutral star or equipotential line according to national or company practice

2 Identification

2.1 Device designation

2.1.1 Nameplate and Certification Plates

The following technical data are given on the instrument nameplate:

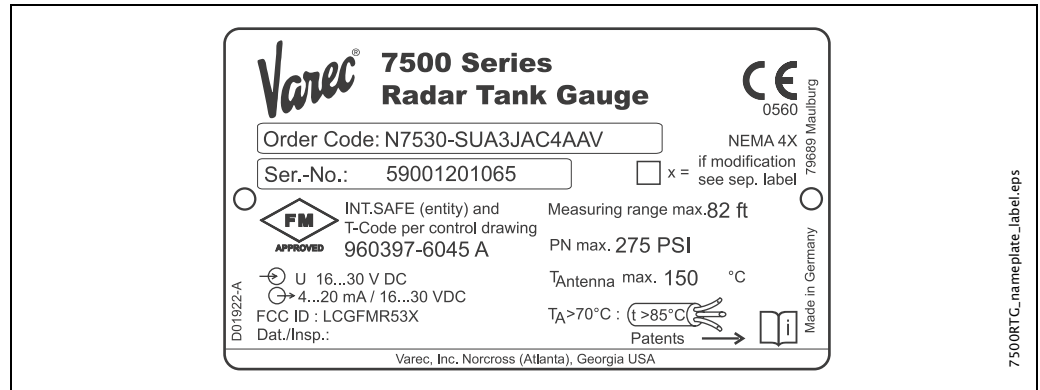


Figure 1: Information on the nameplate of the 7500 RTG (example)

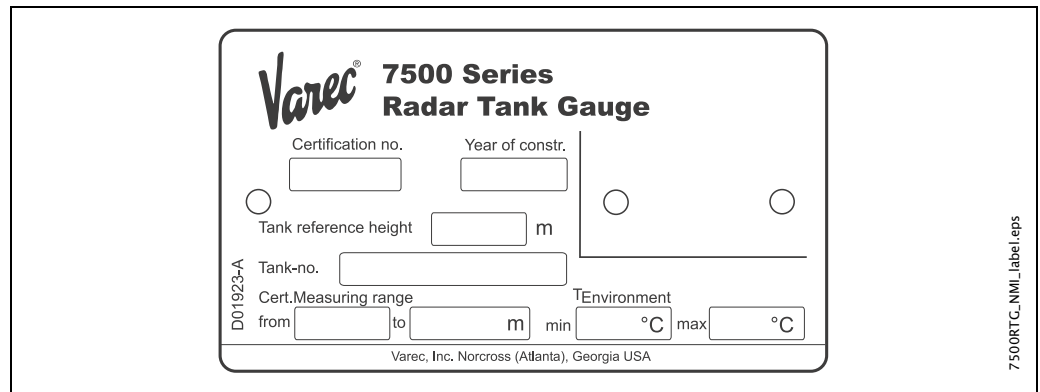


Figure 2: Information on the NMI type plate for custody transfer applications of the 7500 RTG (example)

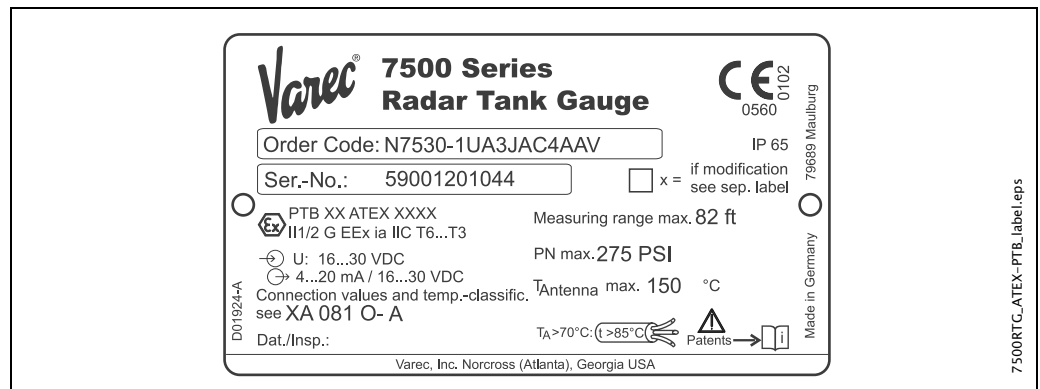


Figure 3: Information on the PTB type plate for custody transfer applications of the 7500 RTG (example)

2.1.2 Ordering structure

Ordering structure 7532 RTG

10	Certificates				Basic weight
A	For non-hazardous areas				6.5 kg
S	FM	IS – Class I, Division 1, Group A–D			
U	CSA	IS – Class I, Division 1, Group A–D			
I	ATEX II 1/2 G	EEx ia IIC T6, note safety instruction (XA) for electrostatic charging!			
Y	Special version				
20	Antenna type				Additional weight
	<i>Type</i>	<i>Size</i>	<i>Material</i>	<i>Sealing</i>	
A	Planar antenna	DN150 / 6"	SS316L	FKM inside	
B	Planar antenna	DN150 / 6"	SS316L	HNBR inside	
E	Planar antenna	DN250 / 10"	SS316L	FKM inside	
F	Planar antenna	DN250 / 10"	SS316L	HNBR inside	2.1 kg
U	Planar antenna	DN200 / 8"	SS316L	FKM inside	
V	Planar antenna	DN200 / 8"	SS316L	HNBR inside	1.1 kg
W	Planar antenna	DN300 / 12"	SS316L	HNBR inside	
X	Planar antenna	DN300 / 12"	SS316L	FKM inside	2.5 kg
Y	Special version				
30	Process connection				
		<i>Flange Dia./Pressure</i>	<i>Standard</i>	<i>Material</i>	
AVJ		6"/150 lbs / RF	ANSI B16.5	316/316L	11.4 kg
A3J		8"/150 lbs / RF	ANSI B16.5	316/316L	19.6 kg
A5J		10"/150 lbs / RF	ANSI B16.5	316/316L	28.8 kg
AWJ		6"/300 lbs / RF	ANSI B16.5	316/316L	20.9 kg
AXJ		8"/300 lbs / RF	ANSI B16.5	316/316L	34.3 kg
A7J		12"/150 lbs / RF	ANSI B16.5	316/316L	43.2 kg
CWJ		DN150 PN10 / 16 C	EN 1092,1, B1 ¹⁾	316L	10.6 kg
CXJ		DN200 PN16 C	EN 1092,1, B1 ¹⁾	316L	16.5 kg
CZJ		DN200 PN25 C	EN 1092,1, B1 ¹⁾	316L	22.7 kg
C1J		DN150 PN25 C	EN 1092,1, B1 ¹⁾	316L	14.7 kg
C6J		DN250 PN16 C	EN 1092,1, B1 ¹⁾	316L	25.6 kg
C8J		DN300 PN16 C	EN 1092,1, B1 ¹⁾	316L	36.1 kg
XXJ		with flange hub		316L	
XVU		Varec UNI-Flange 6"/ DN150/150A, max. 14.5LBS/PN1/1K, compatible with: – 6" 150LBS – DN150 PN16 – 10K 150A		304/1.4301	3.5 kg
X3U		Varec UNI-Flange 8"/ DN200/200A, max. 14.5LBS/PN1/1K, compatible with: – 8" 150LBS – DN200 PN16 – 10K 200A		304/1.4301	5.2 kg
X5U		Varec UNI-Flange 10"/ DN250/250A, max. 14.5LBS/PN1/1K, compatible with: – 10" 150LBS – DN250 PN16 – 10K 250A		304/1.4301	7.5 kg
X7U		Varec UNI-Flange 12"/ DN300/300A, max. 14.5LBS/PN1/1K, compatible with: – 12" 150LBS – DN300 PN16 – 10K 300A		304/1.4301	10.8 kg
YY9	Special version				

1) agreeable to DIN2527 Form C

40											Output and operation
											A 4...20 mA HART with VU 331, 4-line alphanumeric display
											Y Special version
50											Housing
											C Aluminium T12-housing with separate connection compartment, coated, IP65
											Y Special version
60											Gland / Entry
											2 M20x1.5 cable gland
											4 ½ NPT cable entry
											9 Special version
70											Custody transfer approvals
											A NMI, PTB type and test rig approval, weights&measures approved (< 1 mm)
											R Inventory Control Version, not weights&measures approved (3 mm)
											Y Special approval for custody transfer
80											Additional options
											A Without additional options
											Y Special version
7532-											Complete product designation

2.2 Scope of delivery

Caution!

It is essential to follow the instructions concerning the unpacking, transport and storage of measuring instruments given in the section "Incoming acceptance, transport, storage" on page 12.

The scope of delivery consists of:

- Assembled instrument
- ToF Tool (operating program)
- Accessories (Chapter 8)

Accompanying documentation:

- Short manual (basic equalization/troubleshooting): housed in the instrument
- Operating manual (this manual)
- Operating manual: Description of the instrument functions
- Approval documentation: if this is not included in the operating manual.

2.3 Certificates and approvals

CE mark, declaration of conformity

The instrument is designed to meet state-of-the-art safety requirements, has been tested and left the factory in a condition in which it is safe to operate. The instrument complies with the applicable standards and regulations in accordance with EN 61010 "Protection Measures for Electrical Equipment for Measurement, Control, Regulation and Laboratory Procedures". The instrument described in this manual thus complies with the statutory requirements of the EG directives. Varec confirms the successful testing of the instrument by affixing to it the CE mark.

2.4 Registered trademarks

KALREZ[®], VITON[®], TEFLON[®]

Registered trademark of the company E.I. Du Pont de Nemours & Co., Wilmington, USA

TRI-CLAMP[®]

Registered trademark of the company Ladish & Co., Inc., Kenosha, USA

HART[®]

Registered trademark of HART Communication Foundation, Austin, USA

ToF[®]

Registered trademark of the company Endress+Hauser GmbH+Co. KG, Maulburg, Germany

PulseMaster[®]

Registered trademark of the company Endress+Hauser GmbH+Co. KG, Maulburg, Germany

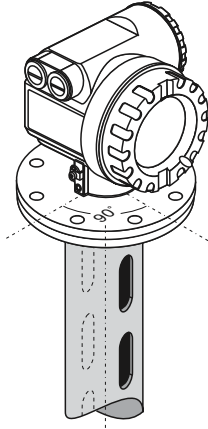
PhaseMaster[®]

Registered trademark of the company Endress+Hauser GmbH+Co. KG, Maulburg, Germany

3 Mounting

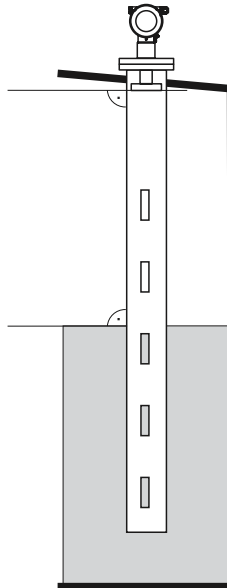
3.1 Quick installation guide

Installation only in stilling well:



The performance of the 7532 RTG planar antenna is not dependent on the alignment or geometry of standard stilling wells.

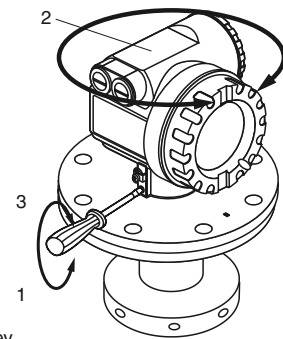
No special alignment is required. However, make sure that the planar antenna is installed vertically relative to the stilling well axis.



Turn housing

The housing can be turned in order to simplify access to the display and the terminal compartment

T12 housing



Allen key
4 mm
tighten strongly
by hand

Note!

The 7532 RTG with planar antenna is designed for use on stilling-wells only!

3.2 Incoming acceptance, transport, storage

3.2.1 Incoming acceptance

Check the packing and contents for any signs of damage.
Check the shipment, make sure nothing is missing and that the scope of supply matches your order.

3.2.2 Transport

Caution!

Follow the safety instructions and transport conditions for instruments of more than 18 kg. Do not lift the measuring instrument by its housing in order to transport it.

3.2.3 Storage

Pack the measuring instrument so that is protected against impacts for storage and transport. The original packing material provides the optimum protection for this.
The permissible storage temperature is $-40\text{ °C} \dots +80\text{ °C}$.

3.3 Installation Conditions

3.3.1 Dimensions

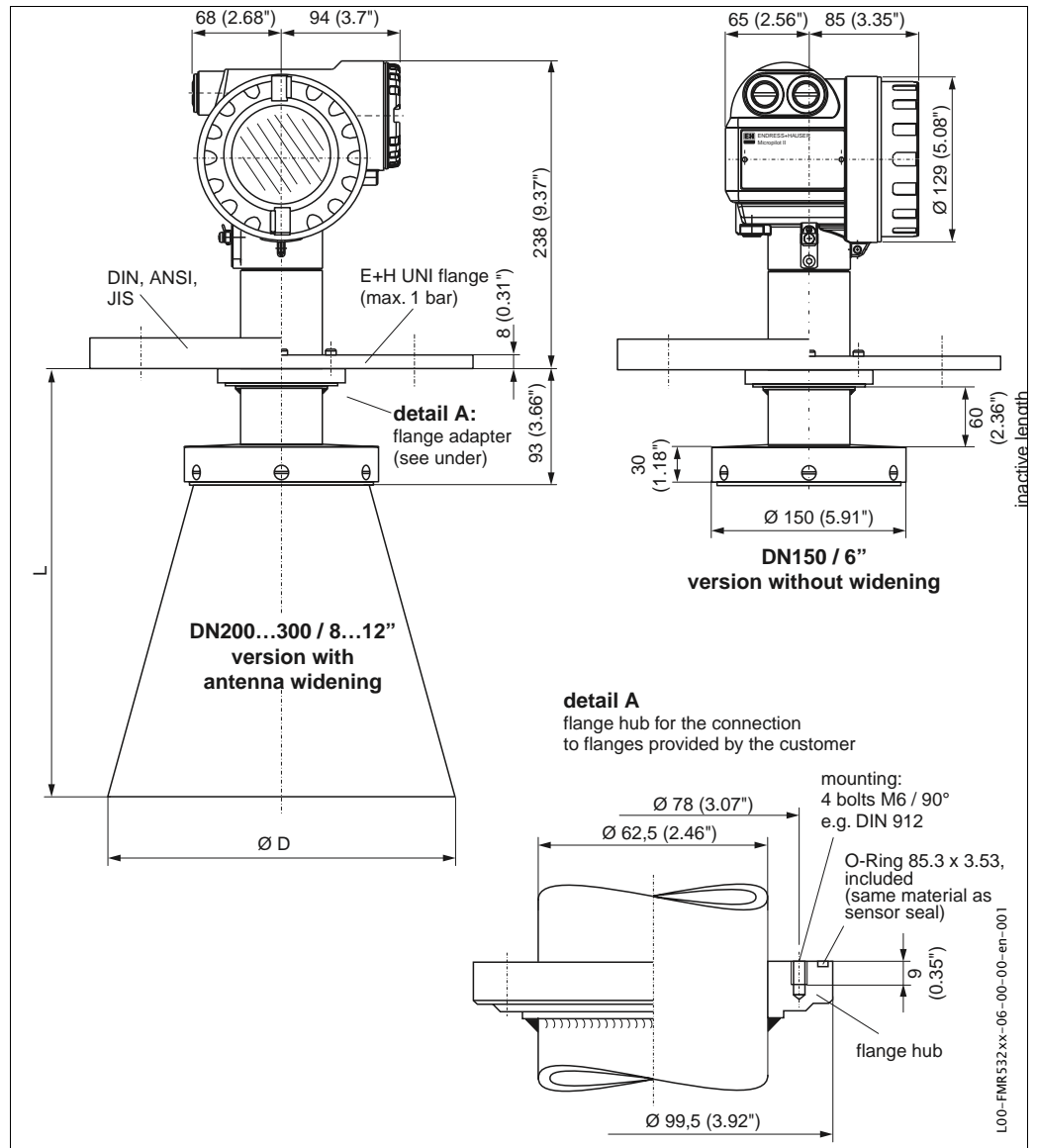


Figure 4: Dimensions 7532 RTG

Antenna version	DN150 / 6"	DN200 / 8"	DN250 / 10"	DN300 / 12"
L [mm]	93	337	490	517
$\varnothing D$ [mm]	no horn	190	240	290

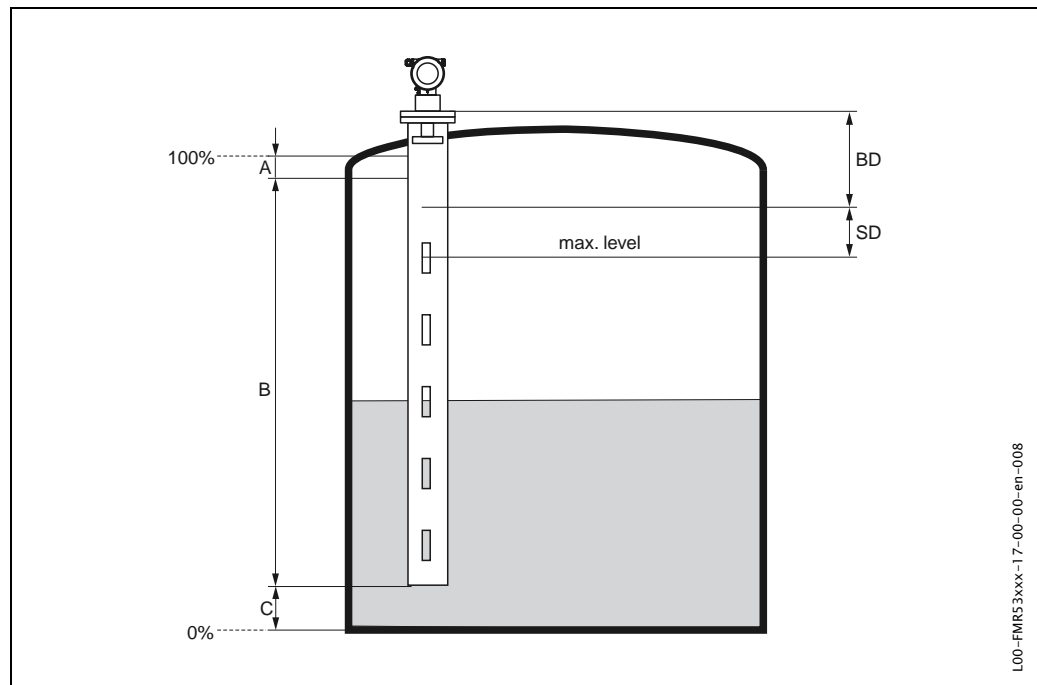
Note!

The inactive length of 60 mm prevents condensation effects to the antenna performance. Special versions with longer construction are available.

3.3.2 Engineering tips

Measuring conditions

- The measuring range starts at the bottom end of the stilling well.
- In case of media with a low dielectric constant (groups A and B), the pipe end can be visible through the medium at low levels. In order to guarantee the required accuracy in these cases, it is recommended to position the zero-point at a distance **C** above the tank bottom (see Fig.).
- In applications with **planar** or **parabolic** antennas, especially for media with low dielectric constants (see page 15), the end of the measuring range should not be closer than 1 m (40") to the flange.
- For **overspill protection**, it is possible to define a safety distance (**SD**) additionally to the blocking distance (**BD**).
- This safety distance (**SD**) is set to 0.5 m (20") by default and generating an alarm in case the level rises inside the safety distance.
- Distance **B** defined the smallest recommended measurement range.
- Depending on its consistence, foam can either absorb microwaves or reflect them off the foam surface. Measurement is possible under certain conditions.



	reference: flange / BD (see picture)		reference: antenna tip (see picture)		
	Blocking distance	Safety distance	recommended additional settings		
	BD [m / ft]	SD [m / ft]	A [mm / inch]	B [m / ft]	C [mm / inch]
7532 RTG (planar)	1 / 3.28	0.5 / 1.6	1000 / 40	0.5 / 1.64	150...300 / 6...12

Behaviour if measuring range is exceeded

The behaviour in case of the measuring range being exceeded can be freely set: the default setting is a current of 22 mA and the generation of a digital warning (E681).

Measuring range

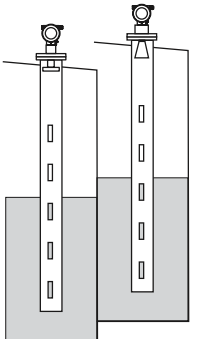
The usable measuring range depends on the size of the antenna, the reflectivity of the medium, the mounting location, and eventual interference reflections.

The following tables describe the groups of media as well as the achievable measuring range as a function of application and media group. If the dielectric constant of a medium is unknown, it is recommended to assume media group B to ensure a reliable measurement.

Product class	DK (ϵ_r)	Examples
A	1.4 ... 1.9	non-conducting liquids, e.g. liquefied gas ¹⁾
B	1.9 ... 4	non-conducting liquids, e.g. benzene, oil, toluene, ...
C	4 ... 10	e.g. concentrated acids, organic solvents, esters, aniline, alcohol, acetone, ...
D	> 10	conducting liquids, e.g. aqueous solutions, dilute acids and alkalis

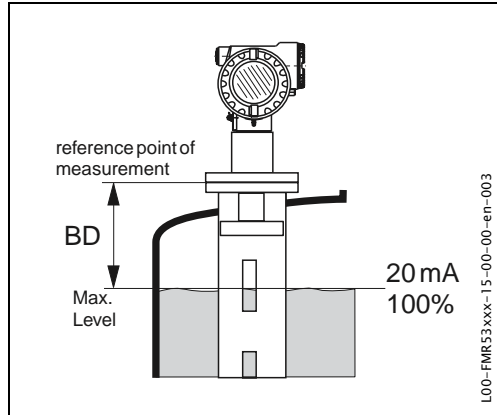
1) Treat Ammonia NH₃ as a medium of group A, e.g. always use a stilling well.

Measuring range depending on product class for 7532 RTG:

Product class		Stilling well/ Bypass
		
		Measuring range
		7532 RTG ≥ DN150
A	DK(ϵ_r)=1,4...1,9	38 m/124 ft
B	DK(ϵ_r)=1,9...4	38 m/124 ft
C	DK(ϵ_r)=4...10	38 m/124 ft
D	DK(ϵ_r)>10	38 m/124 ft
max. measuring range with custody transfer approvals		20 m/65 ft

Blocking distance

The blocking distance (= BD) is the minimum distance from the reference point of the measurement (mounting flange) to the medium surface at maximum level.



Blocking distance (BD)	Stilling well / Bypass
	7532 RTG
from Flange	1 m/40"

Note!

Inside the blocking distance a reliable measurement can not be guaranteed.

3.4 Installation instructions

3.4.1 Mounting kit

In addition to the tool needed for flange mounting, you will require the following tool:

- 4 mm Allen wrench for turning the housing.

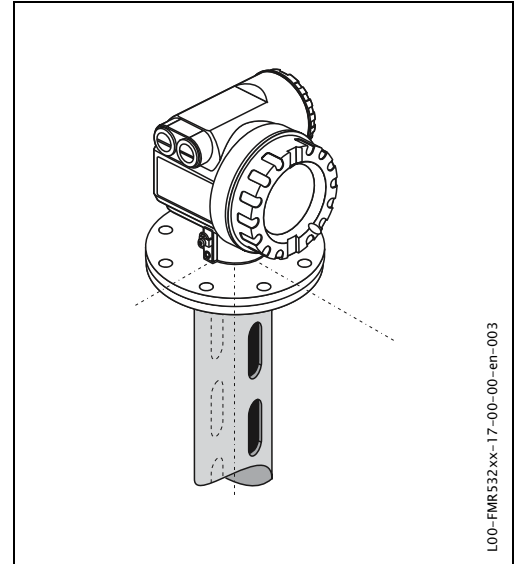
3.4.2 Installation in stilling well

Optimum mounting position for 7532 RTG

Standard installation

When mounting in the stilling well, please observe engineering tips on page 14 and the following points:

- After mounting, the housing can be turned 350° in order to simplify access to the display and the terminal compartment.
- planar axis vertical to flange.
- Measurements can be performed through an open ball valve without any problems.



Recommendations for the stilling well

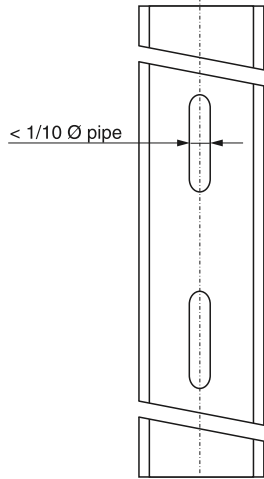
- Metal (no enamel coating, plastic on request).
- Constant diameter.
- Weld seam as smooth as possible and on the same axis as the slots.
- Slots offset 180° (not 90°).
- Slot width respectively diameter of holes max. 1/10 of pipe diameter, de-burred. Length and number do not have any influence on the measurement.
- Select antenna extension as big as possible. For intermediate sizes (e.g. 180 mm) select next larger antenna extension and adapt it mechanically. Maximum gap allowed between the antenna/horn of 7532 RTG and the inside of the stilling well is 5 mm (3/16").
- The antenna extension of the 7532 RTG is mounted with defined pressure. It is strongly recommended **not to dismantle this antenna**.
- Dimensions of a nozzle for manual gauging must be adapted to the dimensions of the horn antenna used, compare to page 23.

Stilling wells with pipe expansion

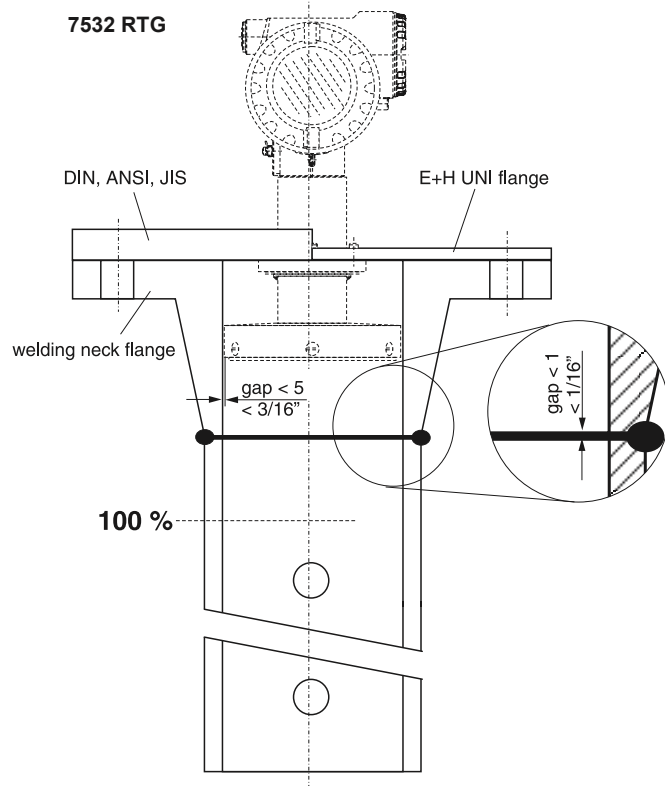
- When using a 7532 RTG, a gradual pipe expansion from DN150 to DN200 / DN200 to DN250 / DN250 to DN300 is acceptable. In such cases, the top end of the piping must have a minimum length of 0.5 m in front of the expansion (see table on page 18). Ideally, a dip socket is used for this.
- Greater expansion of the piping (e.g. DN150 to DN300) is possible if the top end of the pipe is extended accordingly (see table on page 18).
- Avoid pipe expansions at right angles.

Examples for the construction of stilling wells

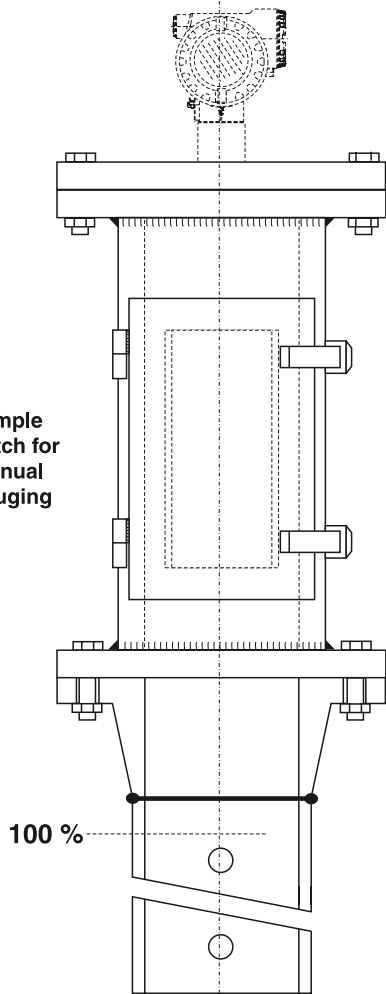
stilling well with slots



7532 RTG



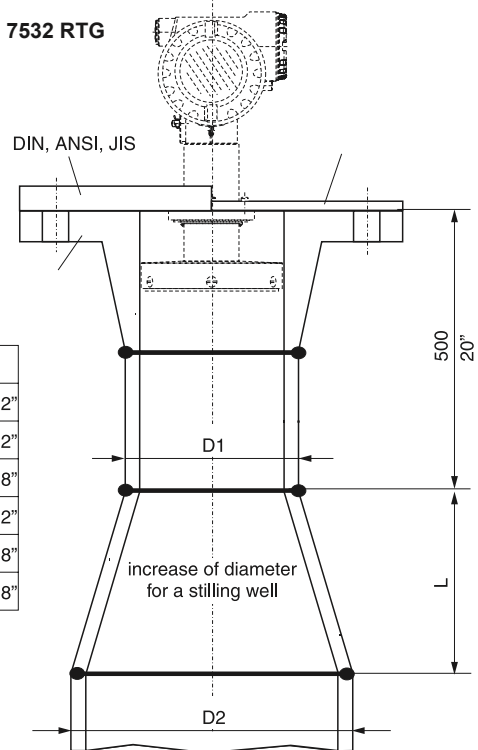
sample hatch for manual gauging



for retrofit of mechanical systems recommended increase of diameter:

D1	D2	L
150 / 6"	200 / 8"	300 / 12"
150 / 6"	250 / 10"	300 / 12"
150 / 6"	300 / 12"	450 / 18"
200 / 8"	250 / 10"	300 / 12"
200 / 8"	300 / 12"	450 / 18"
250 / 10"	300 / 12"	450 / 18"

7532 RTG

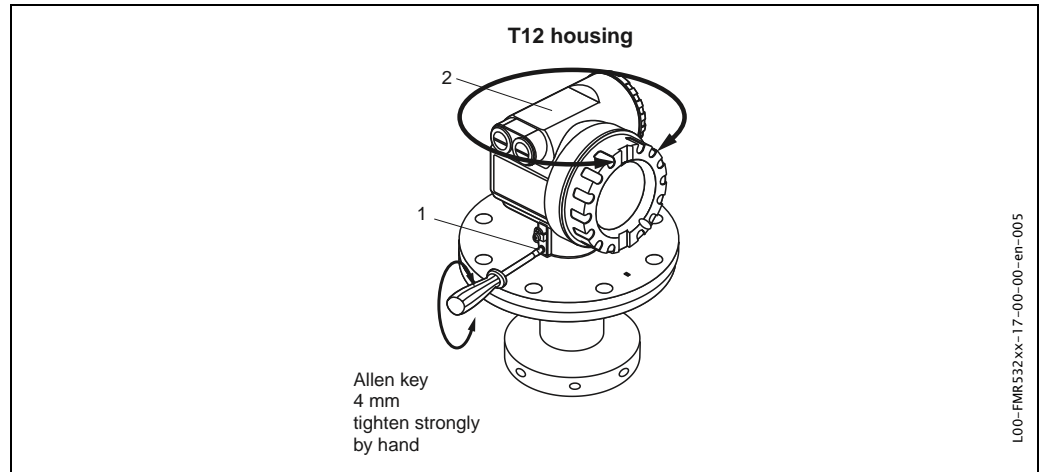


L00-FMRS32x-17-00-00-en-004

3.4.3 Turn housing

After mounting, the housing can be turned 350° in order to simplify access to the display and the terminal compartment. Proceed as follows to turn the housing to the required position:

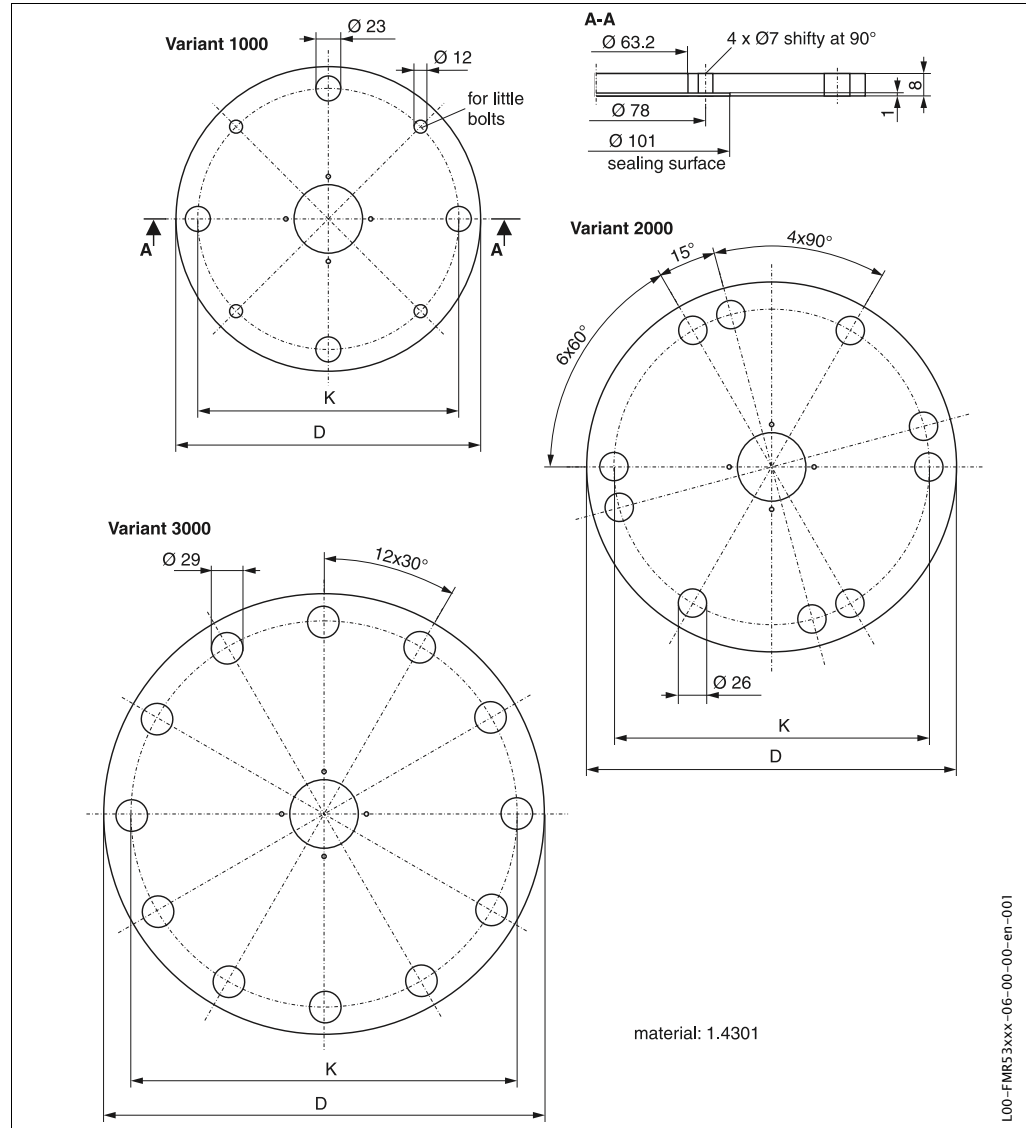
- Undo the fixing screws (1)
- Turn the housing (2) in the required direction
- Tighten up the fixing screws (1)



3.4.4 Installation with Varec UNI flange

Installation tips

Varec UNI flanges are designed for non-pressurized operation respectively max. 1 bar absolute pressure. The number of bolts has sometimes been reduced. The bolt-holes have been enlarged for adaption of dimensions, therefore, the flange needs to be properly aligned to the counterflange before the bolts are tightened.

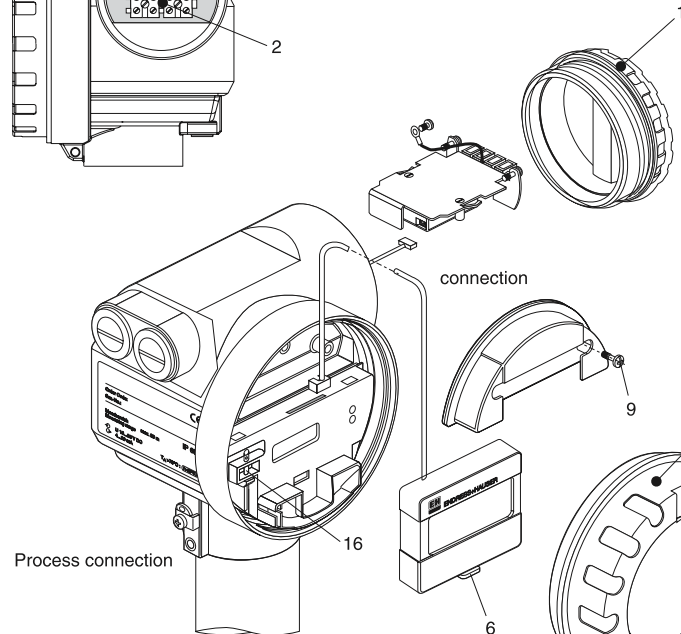
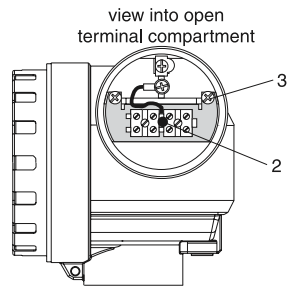


Version	Compatible with	D [mm]	K [mm]	Type plate no.
1000	DN150 PN16 ANSI 6" 150lbs JIS 10K 150	280	240	942455-3001
2000	DN200 PN16 ANSI 8" 150lbs JIS 10K 200	340	294.5	942455-3002
3000	DN250 PN16 ANSI 10" 150lbs JIS 10K 250	405	358	942455-3003
4000	DN300 PN16 ANSI 12" 150lbs JIS 10K 300	482	410 (for DIN), 431,8 (for ANSI), 400 (for JIS), 404,5 (for DIN + JIS)	942455-3004

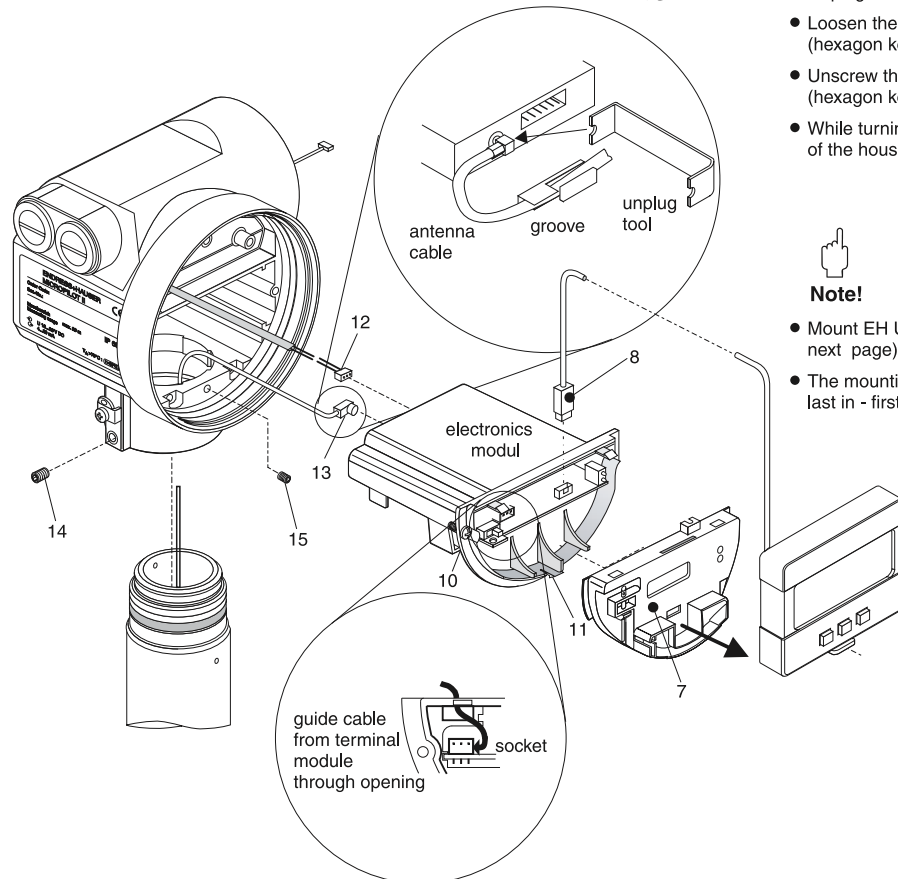
Preparation for the installation of the Varec UNI flange

The mounting requires the following tools:

- Philips screw driver size 1
- flat screw driver for M3 / M4
- hexagon key AF 2.5 / AF 4
- unplug tool for antenna plug (order No. 5200 7646)
- eventually a pair of tweezers



Process connection



Order of exchange:

- Unscrew lid (1) from terminal compartment
- Disconnect cable at terminal module (2)
- Unscrew mounting screws (3) at terminal module and disconnect ground cable
- Pull out terminal module (4). A connection to a cable feed-through is located at the rear side of the module. (the feed-through can be unscrewed, if required)
- Unscrew lid (5) from electronics compartment
- If installed, take display out of holder by pushing the hook (6) upwards
- Break the calibration seal to unplug the sealing pin (16)



If the calibration seal is broken, the national calibration authority should be informed within 24 hours!

Note!

- pull front panel (7) off
- Unplug display cable (8)
- Loosen screw (9) in cover and remove cover
- Loosen mounting screws (10) at electronics module and pull module out of housing
- Press lower hook (11) at module housing slightly inwards
- Unplug connection cable (12) to the terminal module from the electronics
- Unplug antenna cable (13) with unplug tool
- Loosen the set screw (14) in the housing about 1 turn (hexagon key 4 mm)
- Unscrew the stop screw (15) in the housing about 4 - 5 turns (hexagon key 2.5 mm)
- While turning the complete antenna assembly, pull it out of the housing (16) (see next page).

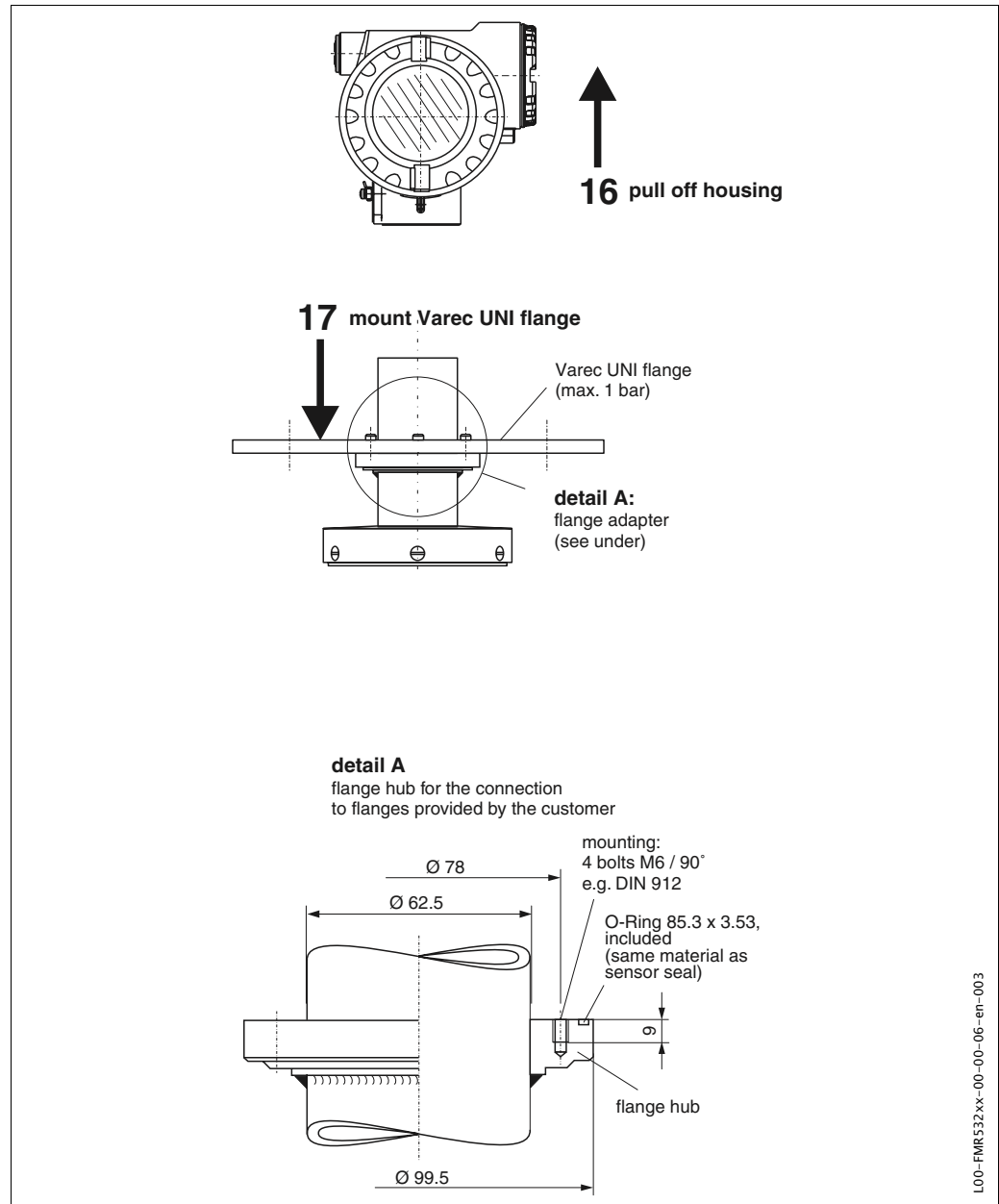


Don't damage the antenna cable!

Note!

- Mount EH UNI flange (17) on flange-hub with screws (see next page).
- The mounting of housing and electronic raised last in - first out how disassembly.

RS32xx-00-00-06-en-002



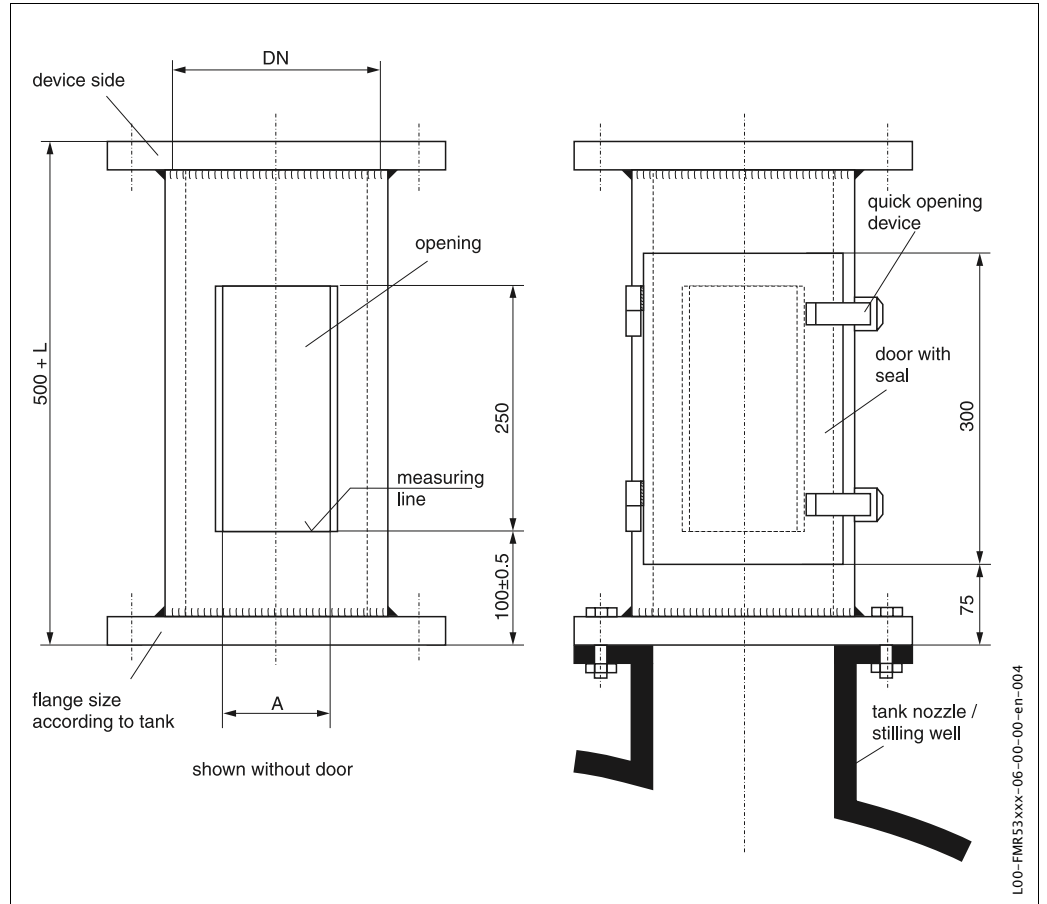
3.4.5 Mounting with Sample hatch on stilling well

Installation tips

For control and cleaning purposes as well as for hand dipping (tape), a sample hatch gauging is recommended. The sensor head can be easily checked in the area of the opening. Manual gauging with gauge rod or tape is possible without removal of the transmitter. The lower edge of the opening is the reference for the gauging. The construction is only suitable for non-pressurized operation.

Note!

The nozzle for manual gauging is not part of the standard offering from Varec. Please contact Varec for further information.



Flange	DN150	DN200	DN250/300
PN [lbs] ²⁾	16	16	16
A [mm]	110	140	170
L [mm]	—	300	450

Flange	ANSI 6"	ANSI 8"	ANSI 10"
PN [lbs] ²⁾	150	150	150
A [mm]	110	140	170
L [mm]	—	300	450

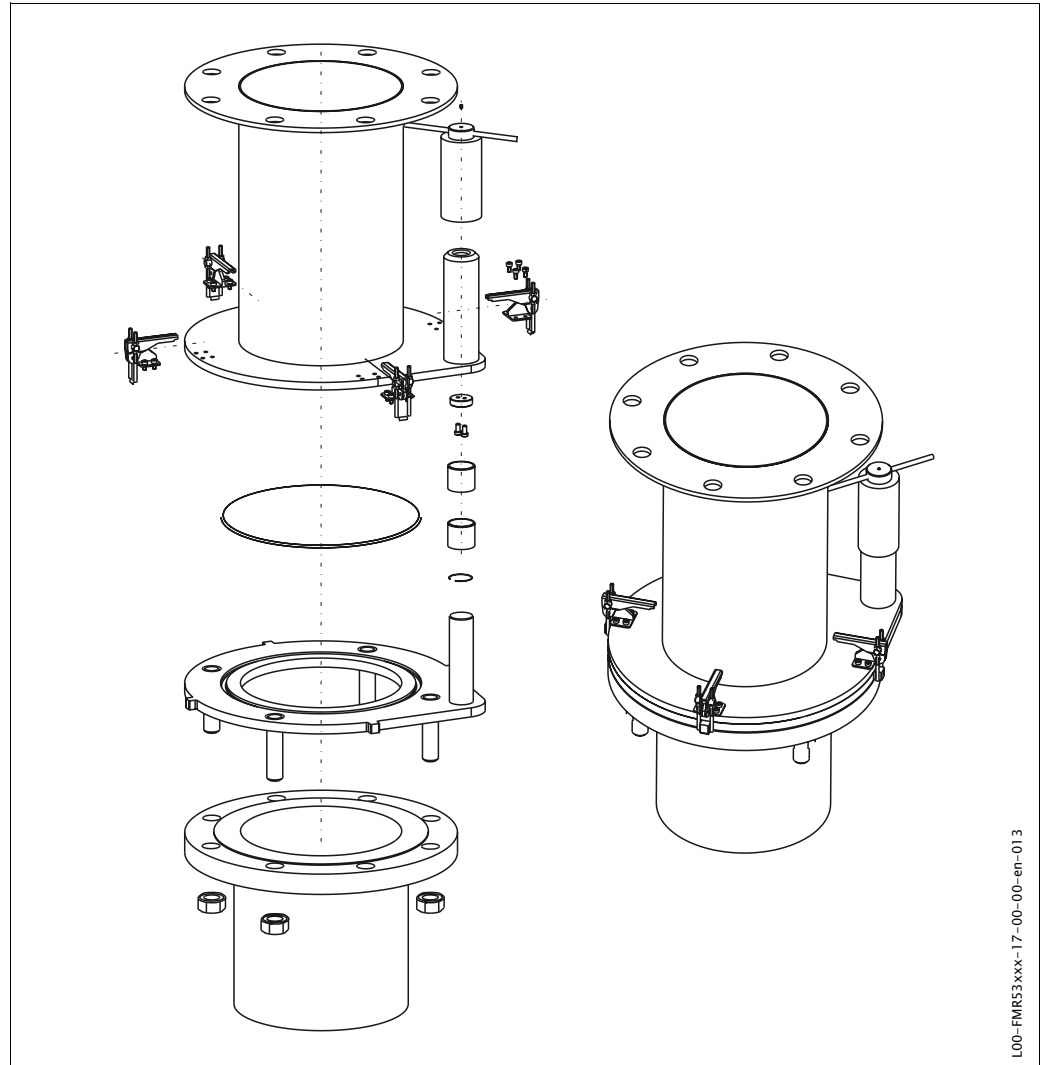
2) Only dimensions adapted to standard. Designed for non-pressurized operation only, therefore thickness of flange can be reduced (e.g. 8mm).

3.4.6 Mounting with Pivoting element

Installation tips

The Pivoting element serves to swivel the 7500 RTG from the measuring position, e.g. to clean the antenna or dip the tank.

The pivoting element is not part of the standard offering from Varec, special offers available under ref. number MVTFM0422.



3.5 Post-installation check

After the measuring instrument has been installed, perform the following checks:

- Is the measuring instrument damaged (visual check)?
- Does the measuring instrument correspond to the measuring point specifications such as process temperature/pressure, ambient temperature, measuring range, etc.?
- Is the flange marking correctly aligned? (see page 11)
- Have the flange screws been tightened up with the respective tightening torque?
- Are the measuring point number and labeling correct (visual check)?
- Is the measuring instrument adequately protected against rain and direct sunlight (see page 75)?

4 Wiring

4.1 Quick wiring guide

When grounding conductive screens, the corresponding directives EN 60079-14 and EN 1127-1 must be observed. Recommendation for safe grounding of conductive screens:

Wiring



Before connection please note the following:

- The power supply must be identical to the data on the nameplate (1).
- Switch off power supply before connecting up the device.
- Connect Equipotential bonding to transmitter ground terminal before connecting up the device.
- Tighten the locking screw: It forms the connection between the antenna and the housing ground potential.



When you use the measuring system in hazardous areas, make sure you comply with national standards and the specifications in the safety instructions (XA's). Make sure you use the specified cable gland.



Connect up the 7500 RTG as follows:

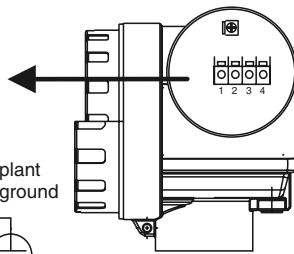
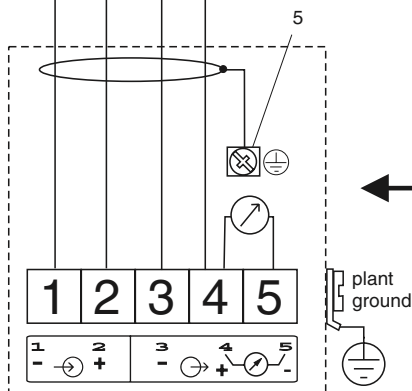
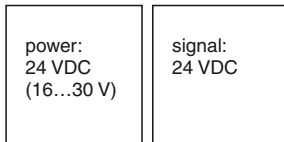
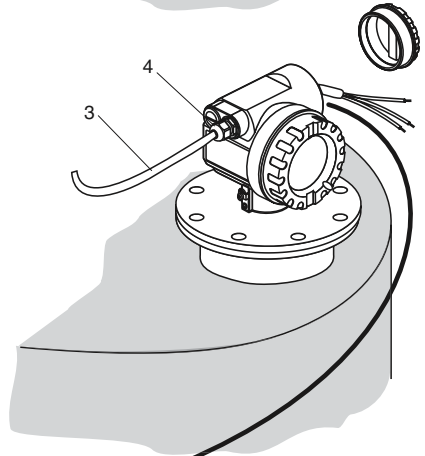
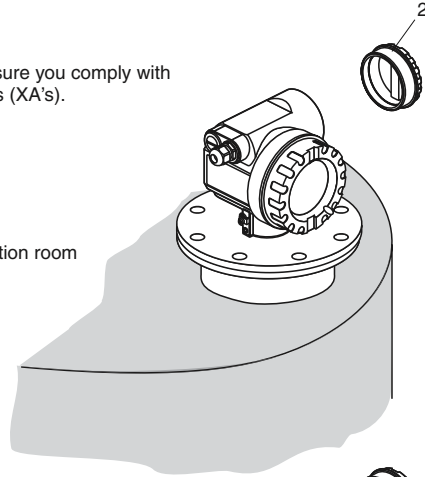
Before unscrew housing cover (2) at separate connection room turn off the power supply!

- Insert cable through gland (3). Use screened, twisted wire pair.



Only ground screening of the line (5) on sensor side.

- Make connection (see pin assignment).
- Tighten cable gland (4).
- Screw off housing cover (2).
- Switch on power supply.



A 7500 RTG situated in a hazardous area is connected as a **single device to a power supply unit and transmitter** situated outside of the hazardous area. In this case, it is recommended that the screen be connected directly to the 7500 RTG at the housing's earth, whereby the 7500 RTG and the power supply unit are connected to the same potential matching line (PML).

75-xx_wiring.eps

Wiring with Tank Side Monitor 4590



Before connection please note the following:

- The power supply must be identical to the data on the nameplate (1).
- Switch off power supply before connecting up the device.
- Connect Equipotential bonding to transmitter ground terminal before connecting up the device.
- Tighten the locking screw:
It forms the connection between the antenna and the housing ground potential.



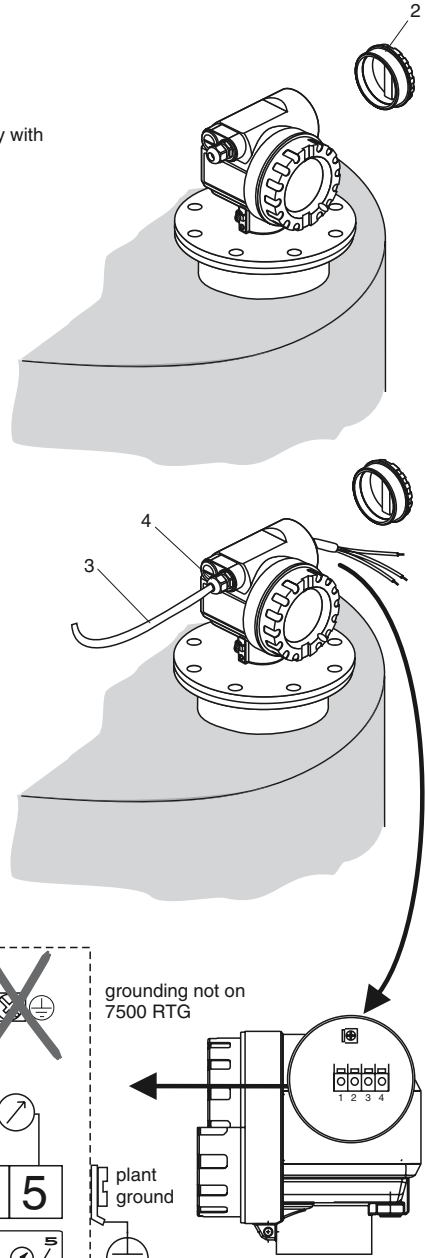
When you use the measuring system in hazardous areas, make sure you comply with national standards and the specifications in the safety instructions (XA's).
Make sure you use the specified cable gland.



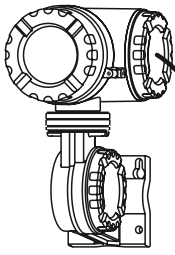
Connect up the 7500 RTG as follows:

Before unscrew housing cover (2) at separate connection room turn off the power supply!

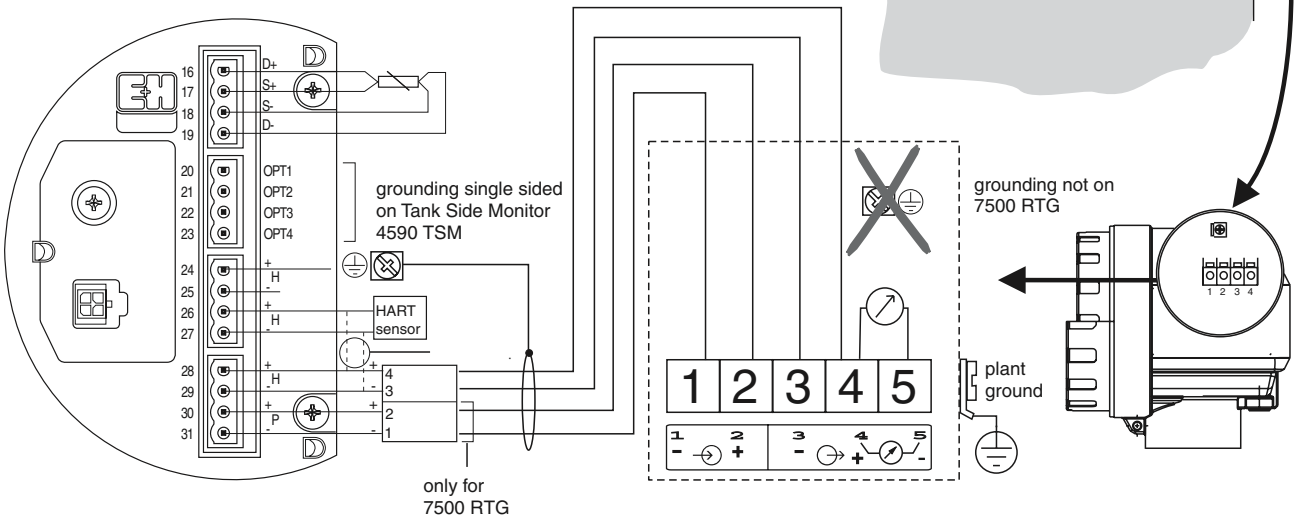
- Insert cable through gland (3).
- Use screened, twisted wire pair.
- Make connection (see pin assignment).
- Tighten cable gland (4).
- Screw off housing cover (2).
- Switch on power supply.



Tank Side Monitor 4590 TSM



intrinsically safe terminal board



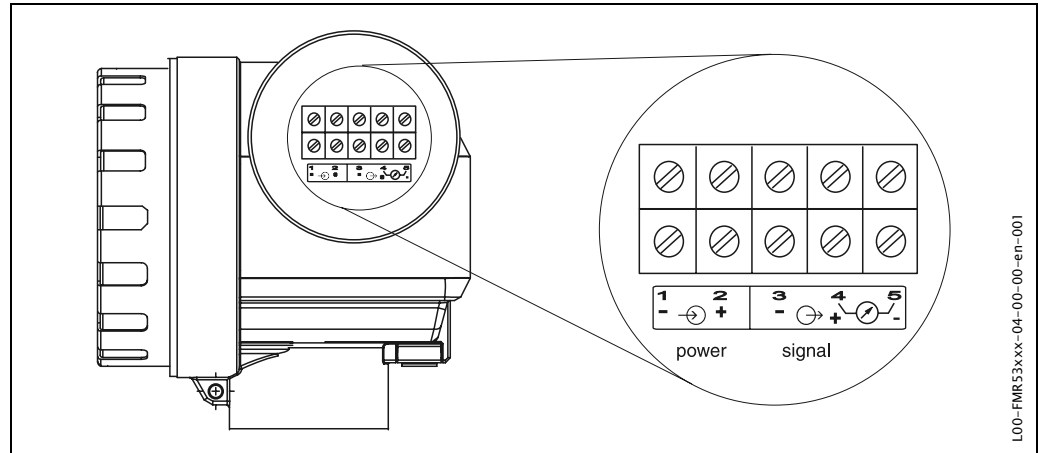
The 7500 RTG is - possibly in combination with other devices - connected to a **Tank Side Monitor** in a hazardous area. In this case, it is recommended that you ground the cable screen centrally at the Tank Side Monitor and connect all devices to the same potential matching line (PML). If, for functional reasons, a capacitive coupling is required between local earth and screen (multiple grounding), ceramic condensers with a dielectric strength of min. 1500 V_{eff} must be used, whereby the total capacitance of 10 nF must not be exceeded. Notes on grounding interconnected intrinsically safe devices are provided by the FISCO model

75.xx_wiring_w_TSM.

4.2 Connecting the measuring unit

Terminal compartment

The housing comes with a separate terminal compartment.



Load HART

Minimum load for Hart communication: 250 Ω

Cable entry

Cable gland: M20x1.5 or Pg13.5

Cable entry: G $\frac{1}{2}$ or $\frac{1}{2}$ NPT

Supply voltage

Direct current voltage: 16...36 VDC

Communication		Terminal voltage	minimal	maximal
Power supply	Standard	U (20 mA) =	16 V	36 V
	Ex	U (20 mA) =	16 V	30 V
Signal	Ex	U (4 mA) =	11,5 V	30 V
		U (20 mA) =	11,5 V	30 V

Power consumption

Max. 330 mW at 16 V, max. 500 mW at 24 V, max. 600 mW at 30 V.

Current consumption

Max. 21 mA (50 mA inrush current).

Power supply

For stand alone operation recommended via e.g. Varec RN 221N.

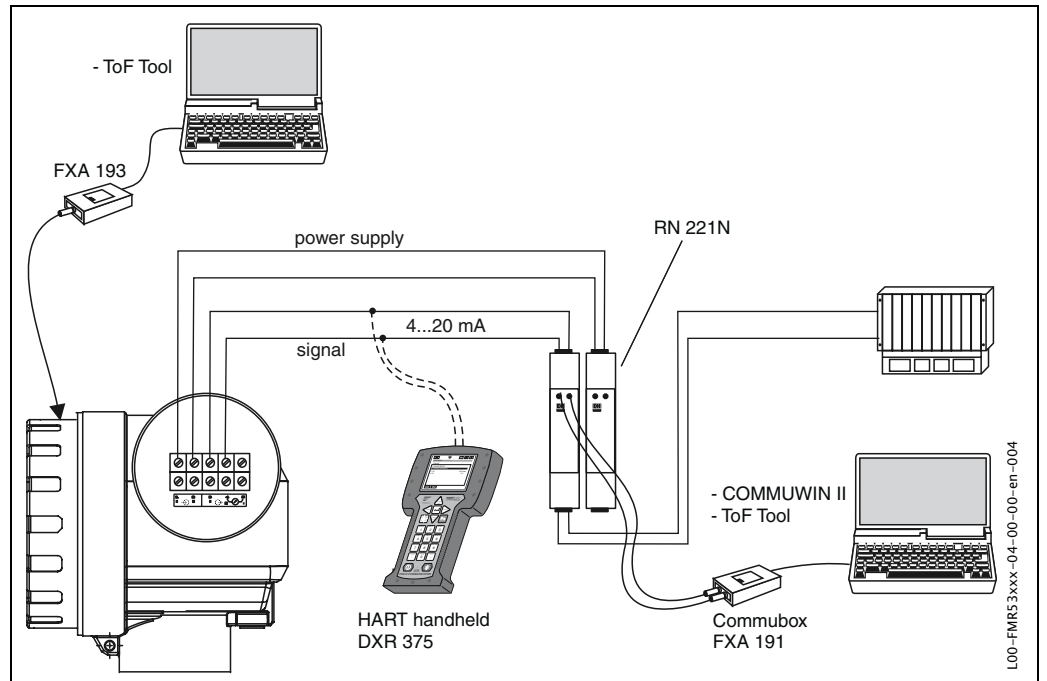
mm accuracy

For measurements with mm accuracy the measured variable must be transmitted using HART protocol to ensure the necessary resolution.

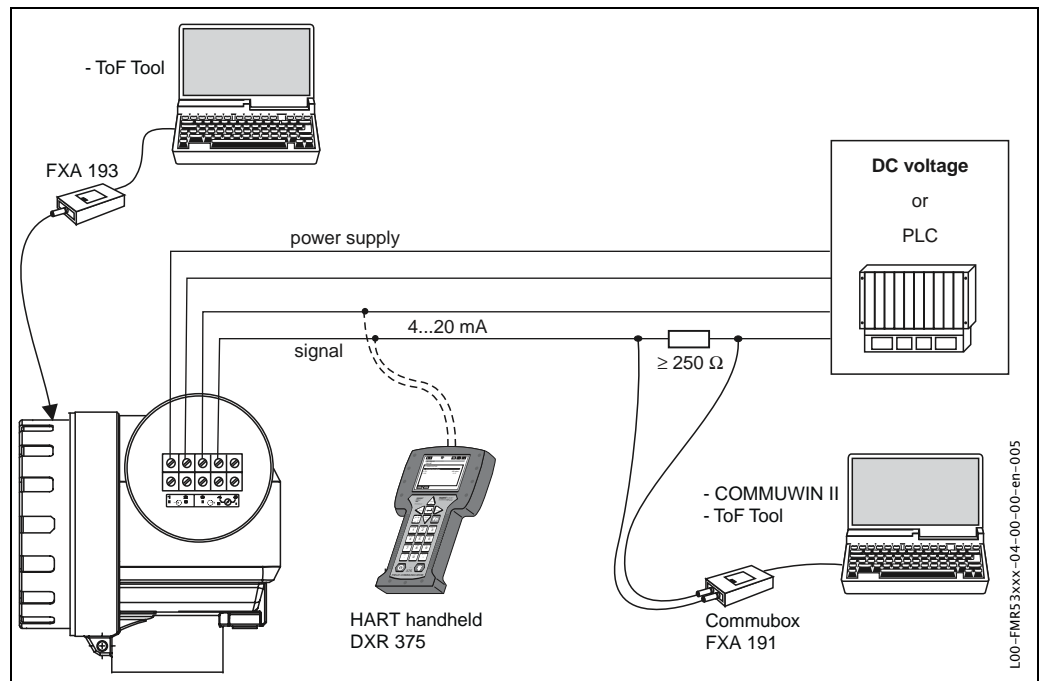
4.2.1 Connection to Tank Side Monitor 4590

See page 27.

4.2.2 HART connection with two Varec RN 221 N



4.2.3 HART connection with other supplies



Caution!

If the HART communication resistor is not built into the supply unit, it is necessary to insert a communication resistor of 250Ω into the 2-wire line.

4.3 Equipotential bonding

Connect the Equipotential bonding to the external ground terminal of the transmitter.

Caution!

In Ex applications, the instrument must only be grounded on the sensor side. Further safety instructions are given in the separate documentation for applications in explosion hazardous areas.

4.4 Degree of protection

- housing: IP 65, NEMA 4X (open housing: IP20, NEMA 1)
- antenna: IP 68 (NEMA 6P)

4.5 Overvoltage protector

- The level transmitter 7500 RTG is equipped with an internal overvoltage protector (600 Vrms electrode). Connect the metallic housing of the 7500 RTG to the tank wall directly with an electrically conductive lead to ensure reliable potential matching.
- Installation with additional overvoltage protector HAW 262 Z (see XA 081F-A "Safety instructions for electrical apparatus certified for use in explosion-hazardous areas").
 - Connect the external overvoltage protector and the 7500 RTG transmitter to the local potential matching system.
 - Potentials shall be equalised both inside and outside the explosion hazardous area.
 - The cable connecting the overvoltage protector and the 7500 RTG transmitter shall not exceed 1 m in length;
 - The cable shall be protected e.g. routed in an armoured hose.

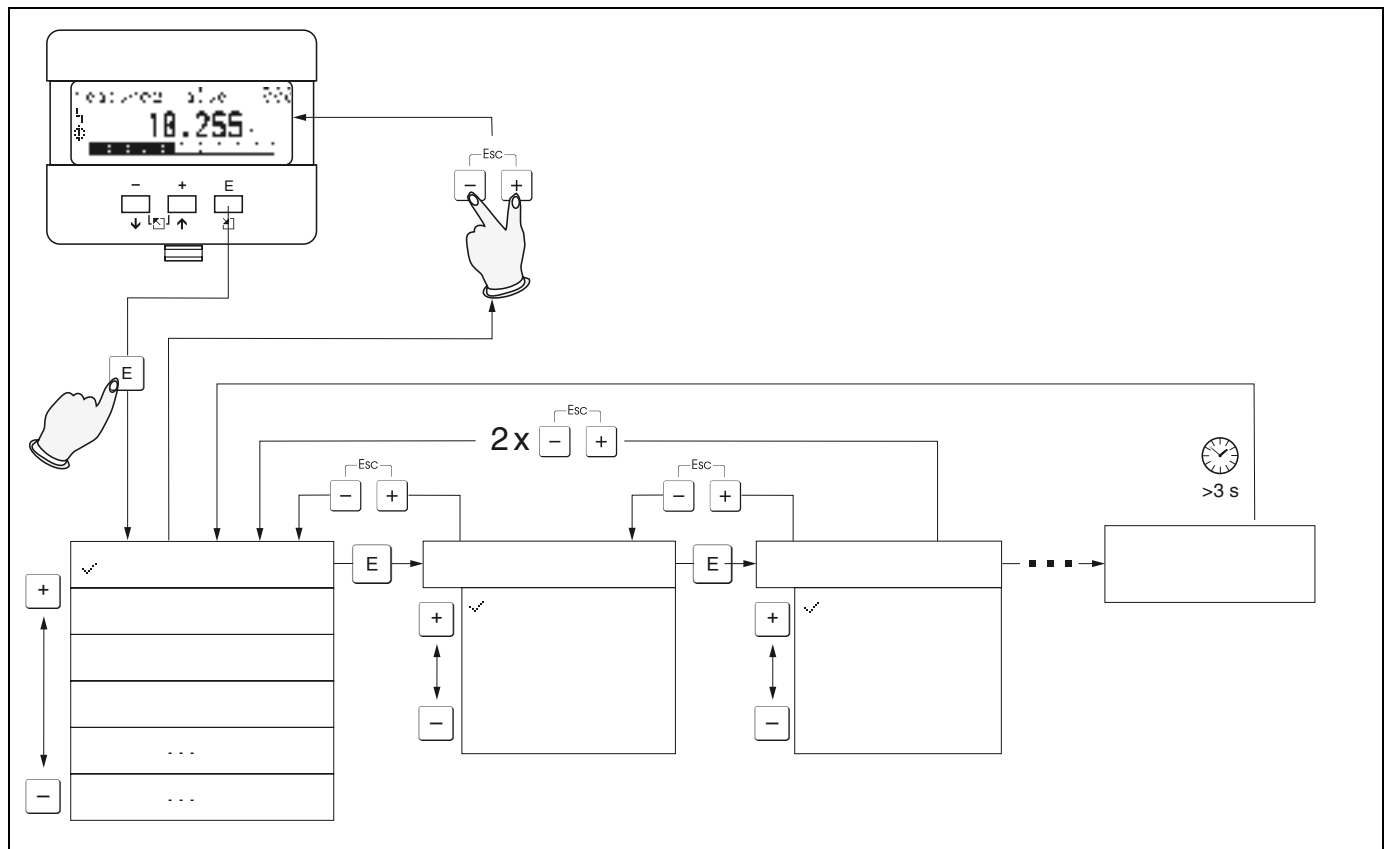
4.6 Post-connection check

After wiring the measuring instrument, perform the following checks:

- Is the terminal allocation correct (see page 25)?
- Is the cable gland tight?
- Is the housing cover screwed tight?
- If auxiliary power is available:
Is the instrument ready for operation and does the liquid crystal display show any value?

5 Operation

5.1 Quick operation guide



Selection and configuration in Operation menu:

- 1.) Change from Measured Value Display to **Group Selection** by pressing **E**
- 2.) Press **-** or **+** to select the required **Function Group** (e.g.. "basic setup (00)") and confirm by pressing **E** → **First function** (e.g. "tank shape (002)") is selected.

Note!

The active selection is marked by a **✓** in front of the menu text.

- 3.) Activate Edit mode with **+** or **-**.

Selection menus:

- a) Select the required **Parameter** in selected **function** (e.g. "tank shape (002)") with **-** or **+**.
- b) **E** confirms selection → **✓** appears in front of the selected parameter
- c) **E** confirms the edited value → system quits Edit mode
- d) **+** + **-** (= **ESC**) interrupts selection → system quits Edit mode

Typing in numerals and text:

- a) Press **+** or **-** to edit the first character of the **numeral / text** (e.g. "empty calibr. (005)")
- b) **E** positions the cursor at the next character → continue with (a) until you have completed your input
- c) if a **␣** symbol appears at the cursor, press **E** to accept the value entered → system quits Edit mode
- d) **+** + **-** (= **ESC**) interrupts the input, system quits Edit mode

- 4) Press **E** to select the next **function** (e.g. "medium property (003)")
- 5) Press **+** + **-** (= **ESC**) once → return to previous **function** (e.g. "tank shape (002)")
 Press **+** + **-** (= **ESC**) twice → return to **Group selection**
- 6) Press **+** + **-** (= **ESC**) to return to **Measured value display**

L00-FMR2xxx-19-00-00-en-001

5.1.1 General structure of the operating menu

The operating menu is made up of two levels:

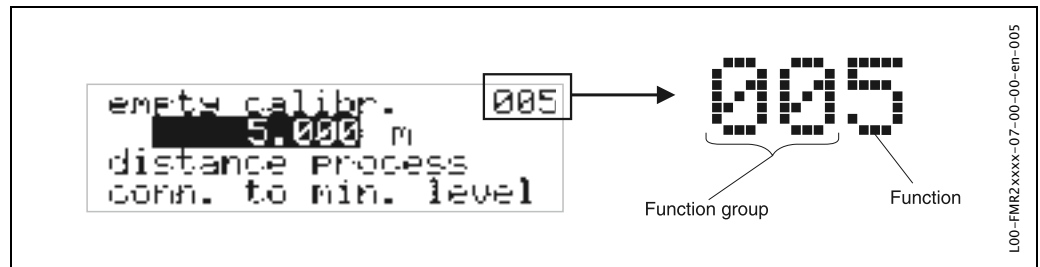
- **Function groups (00, 01, 03, ..., 0C, 0D):**
The individual operating options of the instrument are split up roughly into different function groups. The function groups that are available include, e.g.: "basic setup", "safety settings", "output", "display", etc.
- **Functions (001, 002, 003, ..., 0D8, 0D9):**
Each function group consists of one or more functions. The functions perform the actual operation or parameterization of the instrument. Numerical values can be entered here and parameters can be selected and saved. The available functions of the "basic setup (00)" function group include, e.g.: "tank shape (002)", "medium property (003)", "process cond. (004)", "empty calibr. (005)", etc.

If, for example, the application of the instrument is to be changed, carry out the following procedure:

1. Select the "basic setup (00)" function group.
2. Select the "tank shape (002)" function (where the existing tank shape is selected).

5.1.2 Identifying the functions

For simple orientation within the function menus (see page 91), for each function a position is shown on the display.



The first two digits identify the function group:

- **basic setup** 00
- **safety settings** 01
- **linearization** 04

...

The third digit numbers the individual functions within the function group:

- **basic setup** 00 →
- **tank shape** 002
- **medium property** 003
- **process cond.** 004

...

Here after the position is always given in brackets (e.g. "tank shape" (002)) after the described function.

5.2 Display and operating elements

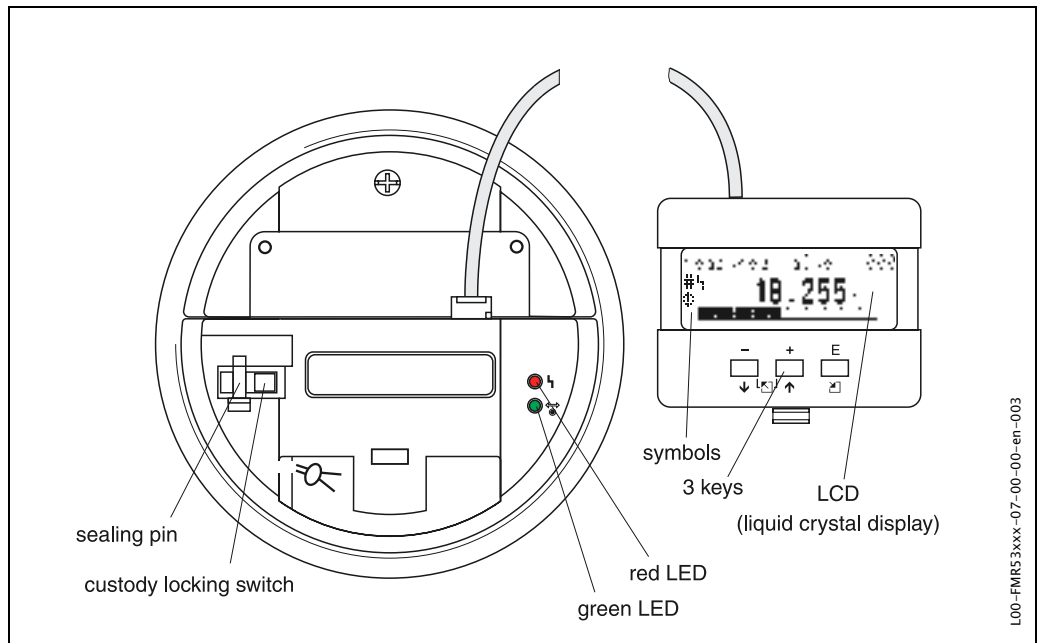


Figure 5: Layout of the display and operating elements

5.2.1 Display

Liquid crystal display (LCD):

Four lines with 20 characters each. Display contrast adjustable through key combination.

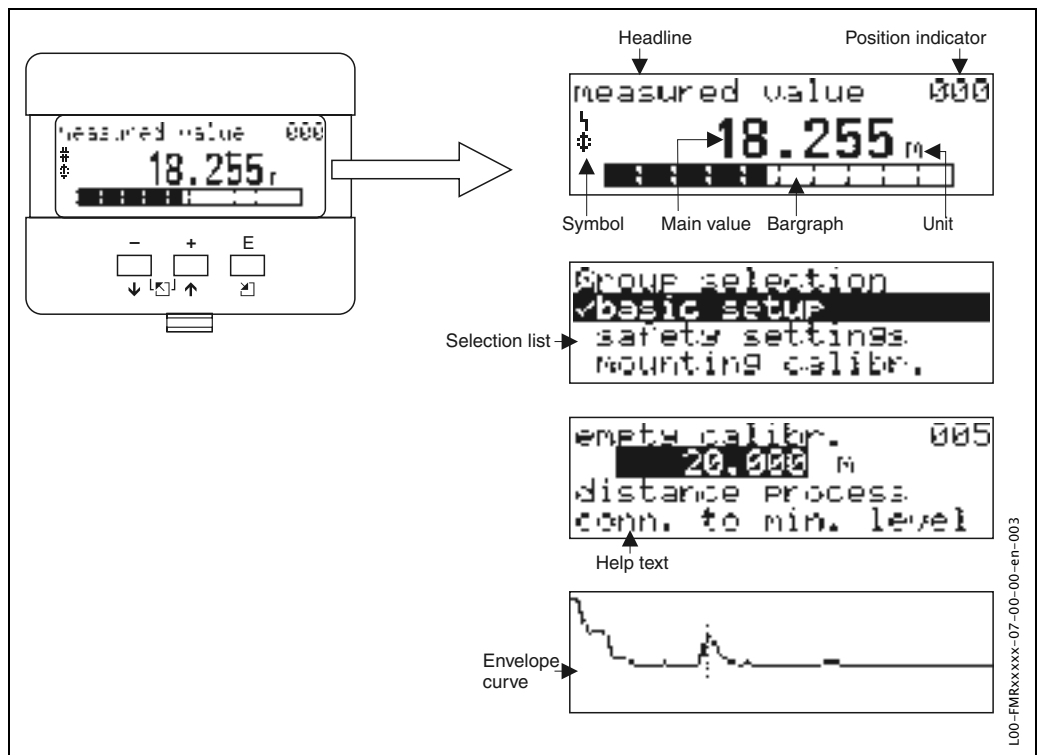


Figure 6: Display

5.2.2 Display symbols

The following table describes the symbols that appear on the liquid crystal display:





Symbols	Meaning
	ALARM_SYMBOL This alarm symbol appears when the instrument is in an alarm state. If the symbol flashes, this indicates a warning.
	LOCK_SYMBOL This lock symbol appears when the instrument is locked, i.e. if no input is possible.
	COM_SYMBOL This communication symbol appears when a data transmission via e.g. HART, PROFIBUS-PA or Foundation Fieldbus is in progress.
	Calibration to regulatory standards disturbed If the instrument is not locked or it cannot guarantee the calibration to regulatory standards, the situation will be indicated on the display via the symbol.

Table 1: Meaning of the symbols

Light emitting diodes (LEDs):

There is a green and a red LED besides the Liquid Crystal Display.

LED	Meaning
red LED continuously on	Alarm
red LED flashes	Warning
red LED off	No alarm
green LED continuously on	Operation
Green LED flashes	Communication with external device

5.2.3 Key assignment

The operating elements are located inside the housing and are accessible for operation by opening the lid of the housing.

Function of the keys
















Key(s)	Meaning
 or 	Navigate upwards in the selection list Edit numeric value within a function
 or 	Navigate downwards in the selection list Edit numeric value within a function
 or 	Navigate to the left within a function group
 or 	Navigate to the right within a function group, confirmation.
 and  or  and 	Contrast settings of the LCD
 and  and 	Hardware lock / unlock After a hardware lock, an operation of the instrument via display or communication is not possible! The hardware can only be unlocked via the display. An unlock parameter must be entered to do so.

Table 2: Function of the keys

Custody locking switch

Access to the electronics can be prevented by means of a custody locking switch that locks the device settings; see fig. 4 on Page 34.

The custody locking switch can be sealed for custody transfer applications.

Software reliability

The software used in the 7500 RTG fulfills the requirements of OIML R85. This particularly includes:

- cyclical test of data consistency
- non-volatile memory
- segmented data storage


The 7500 RTG continuously monitor the compliance with accuracy requirements for custody transfer measurements according to OIML R85. If the accuracy cannot be maintained, a specific alarm is generated on the local display and via the digital communication

5.3 Local operation








5.3.1 Locking of the configuration mode

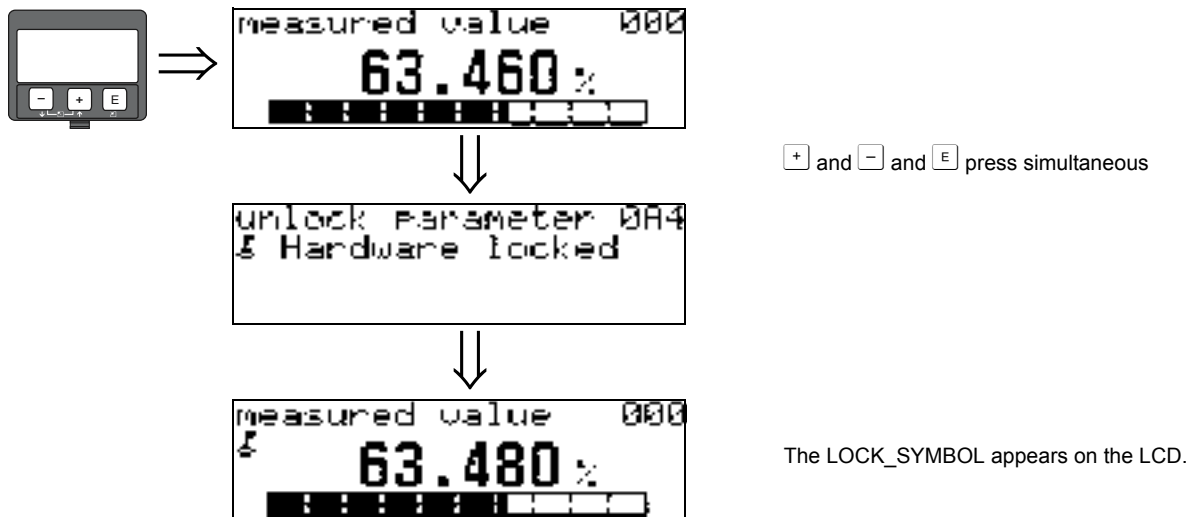
The 7500 RTG can be protected in two ways against unauthorized changing of instrument data, numerical values or factory settings:

"unlock parameter" (0A4):

A value ≤ 100 (e.g. 99) must be entered in "unlock parameter" (0A4) in the "diagnostics" (0A) function group. The lock is shown on the display by the  symbol and can be released again either via the display or by communication.

Hardware lock:

The instrument is locked by pressing the  and  and  keys at the same time. The lock is shown on the display by the  symbol and can **only** be unlocked again via the display by pressing the ,  and  keys at the same time again. It is **not** possible to unlock the hardware by communication. All parameters can be displayed even if the instrument is locked.



5.3.2 Unlocking of configuration mode

If an attempt is made to change parameters when the instrument is locked, the user is automatically requested to unlock the instrument:

"unlock parameter" (0A4):

By entering the unlock parameter (on the display or via communication)

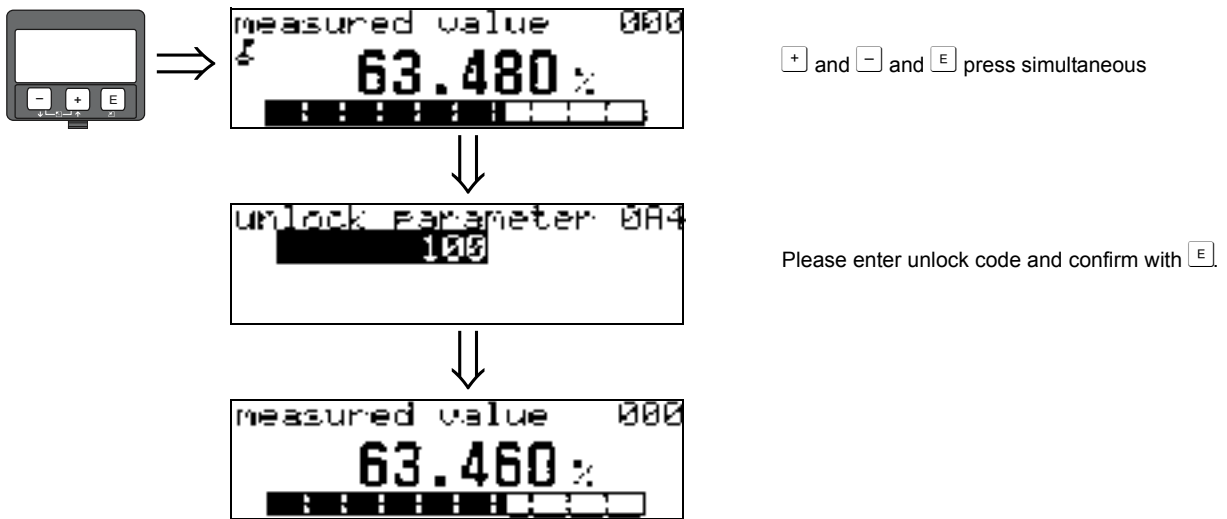
100 = for HART devices

the 7500 RTG is released for operation.

Hardware lock:

After pressing the **+** and **-** and **E** keys at the same time, the user is asked to enter the unlock parameter

100 = for HART devices.



Caution!

Changing certain parameters such as all sensor characteristics, for example, influences numerous functions of the entire measuring system, particularly measuring accuracy. There is no need to change these parameters under normal circumstances and consequently, they are protected by a special code known only to the Varec service organization. Please contact Varec if you have any questions.

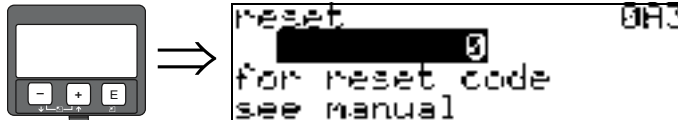
5.3.3 Factory settings (Reset)

Caution!

A reset sets the instrument back to the factory settings. This can lead to an impairment of the measurement. Generally, you should perform a basic setup again following a reset.

A reset is only necessary:

- if the instrument no longer functions
- if the instrument must be moved from one measuring point to another
- if the instrument is being de-installed /put into storage/installed



User input ("reset" (0A3)):

- 333 = customer parameters
- 555 = History

333 = reset customer parameters

This reset is recommended whenever an instrument with an unknown 'history' is to be used in an application:

- The 7500 RTG is reset to the default values.
- The customer specific tank map is not deleted.
- A linearization is switched to "**linear**" although the table values are retained. The table can be reactivated in the "**linearization**" (04) function group.

List of functions that are affected by a reset:

- | | |
|-------------------------|--------------------------|
| • tank shape (002) | • linearization (041) |
| • empty calibr. (005) | • customer unit (042) |
| • full calibr. (006) | • diameter vessel (047) |
| • pipe diameter (007) | • range of mapping (052) |
| • output on alarm (010) | • pres. Map dist (054) |
| • output on alarm (011) | • offset (057) |
| • outp. echo loss (012) | • low output limit (062) |
| • ramp %span/min (013) | • fixed current (063) |
| • delay time (014) | • fixed cur. value (064) |
| • safety distance (015) | • simulation (065) |
| • in safety dist. (016) | • simulation value (066) |
| • Tank Gauging (030) | • format display (094) |
| • auto correction (031) | • distance unit (0C5) |
| • level/ullage (040) | • download mode (0C8) |

555 = History Reset

After mounting and aligning the equipment, carry out a history reset before switching on the function "**Auto-correction**" (031) (see page 57).

The **tank map** can also be reset in the "**cust. tank map**" (055) function of the "**extended calibr.**" (05) function group.

This reset is recommended whenever an instrument with an unknown 'history' is to be used in an application or if a faulty mapping was started:




- The tank map is deleted. The mapping must be recommenced.

5.4 Display and acknowledging error messages

Type of error

Errors that occur during commissioning or measuring are displayed immediately on the local display. If two or more system or process errors occur, the error with the highest priority is the one shown on the display.



The measuring system distinguishes between two types of error:

- **A (Alarm):**
Instrument goes into a defined state (e.g. MAX 22 mA)
Indicated by a constant  symbol.
(For a description of the codes, see Table 9.2 on Page 79)
- **W (Warning):**
Instrument continue measuring, error message is displayed.
Indicated by a flashing  symbol.
(For a description of the codes, see Table 9.2 on Page 79)
- **E (Alarm / Warning):**
Configurable (e.g. loss of echo, level within the safety distance)
Indicated by a constant/flashing  symbol.
(For a description of the codes, see Table 9.2 on Page 79)



Error messages

Error messages appear as four lines of plain text on the display. In addition, a unique error code is also output. A description of the error codes is given on page 79.

- The "**diagnostics (0A)**" function group can display current errors as well as the last errors that occurred.
- If several current errors occur, use  or  to page through the error messages.
- The last occurring error can be deleted in the "**diagnostics (0A)**" function group with the function "clear last error" (**0A2**).

5.5 HART communication

Apart from local operation, you can also parameterize the measuring instrument and view measured values by means of a HART protocol. There are two options available for operation:

- Operation via the universal handheld operating unit, the HART Communicator DXR 375.
- Operation via the Personal Computer (PC) using the operating program (e.g. ToF Tool or Commuwin II) (For connections, see page 29).
- Operation via the Tank Side Monitor 4590.

5.5.1 Handheld unit DXR 375

All device functions can be adjusted via menu operation with the handheld unit DXR 375.

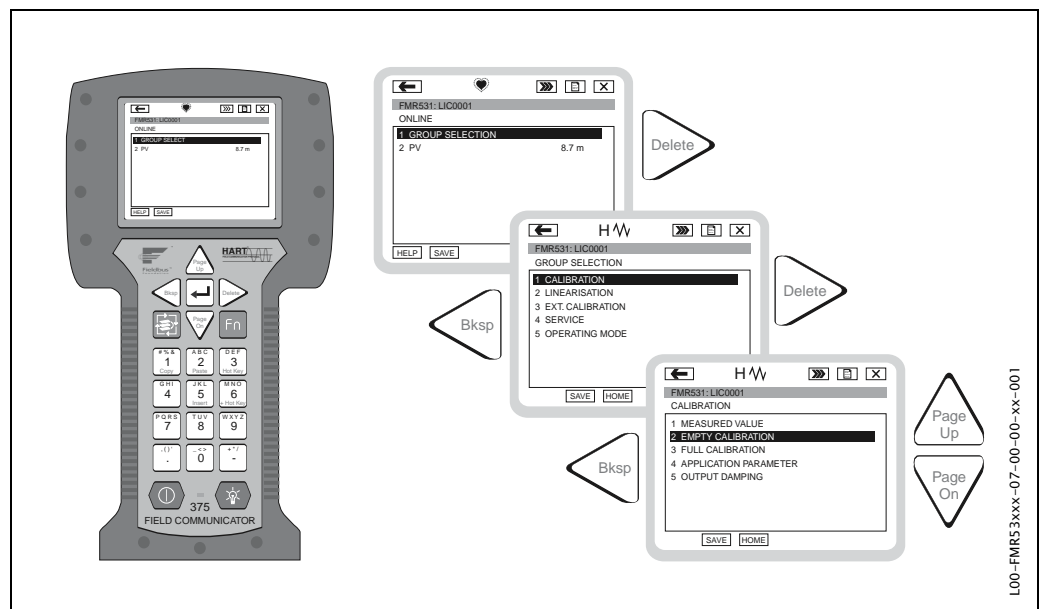


Figure 7: Menu operation with the DXR 375 handheld instrument

Note!

- Further information on the HART handheld unit is given in the respective operating manual included in the transport bag of the instrument.

5.5.2 ToF Tool operating program

The ToF Tool is a graphical operating software for instruments from Varec that operate based on the time-of-flight principle. It is used to support commissioning, securing of data, signal analysis and documentation of the instruments. It is compatible with the following operating systems: Win95, Win98, WinNT4.0, Win2000 and Windows XP.

The ToF Tool supports the following functions:

- Online configuration of transmitters
- Signal analysis via envelope curve
- Loading and saving of instrument data (Upload/Download)
- Documentation of measuring point

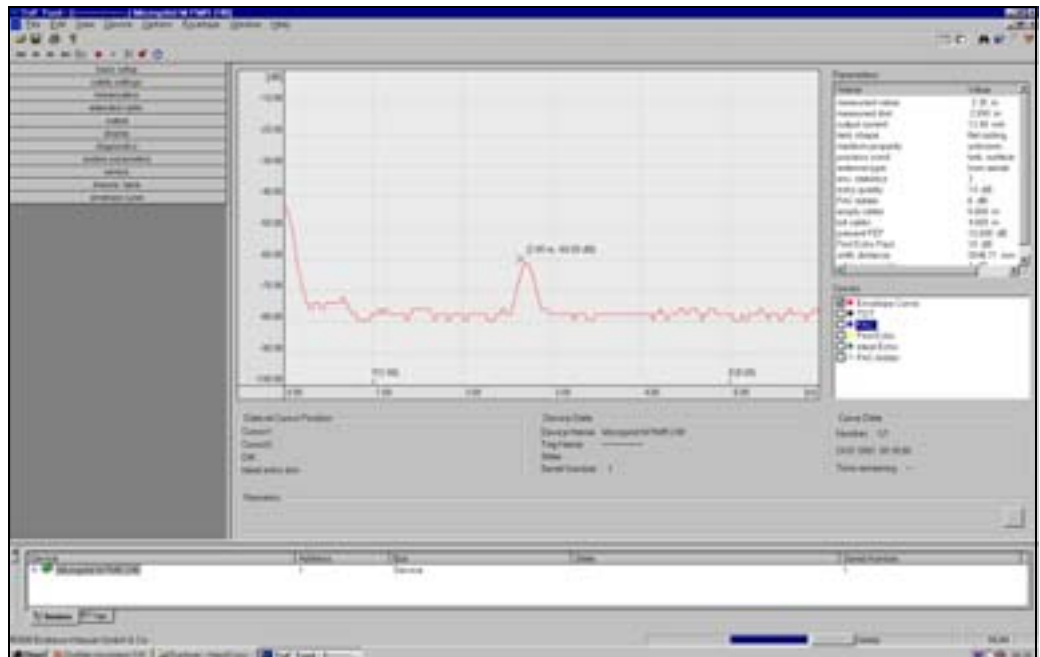
Note!

Further information you may find on the CD-ROM, which is enclosed to the instrument.

Menu-guided commissioning



Signal analysis via envelope curve



Connection options:

- Service-interface with adapter FXA 193 (see page 29)
- HART with Commubox FXA 191 (see page 29)

5.5.3 Commuwin II-Operating Program

Commuwin II is an operating software with graphical support for intelligent transmitters with the communication protocols Rackbus, Rackbus RS 485, INTENSOR, HART or PROFIBUS-PA. It is compatible with the operating systems Win 3.1/3.11, Win95, Win98 and WinNT4.0. All functions of Commuwin II are supported. The configuration is made via operating matrix or graphic surface. An envelope curve can be displayed in ToF Tool.

Note!

Further information on Commuwin II is given in the following Varec documentation:

- System Information: SI 018F/00/en "Commuwin II"
- Operating Manual: BA 124F/00/en "Commuwin II" operating program

Connection

The table provides an overview of the Commuwin connections.

Interface	Hardware	Server	Device list
HART	Commubox FXA 191 to HART Computer with RS-232C interface	HART	Connected instrument
	Interface FXN 672 Gateway for MODBUS, PROFIBUS, FIP, INTERBUS, etc. Computer with RS-232C interface or PROFIBUS card	ZA 673 for PROFIBUS ZA 672 for other	List of all rack bus modules: the required FXN 672 must be selected

Note!

The 7500 RTG can also be operated locally using the keys. If operation is prevented by the keys being locked locally, parameter entry via communication is not possible either.

6 Commissioning

6.1 Function check

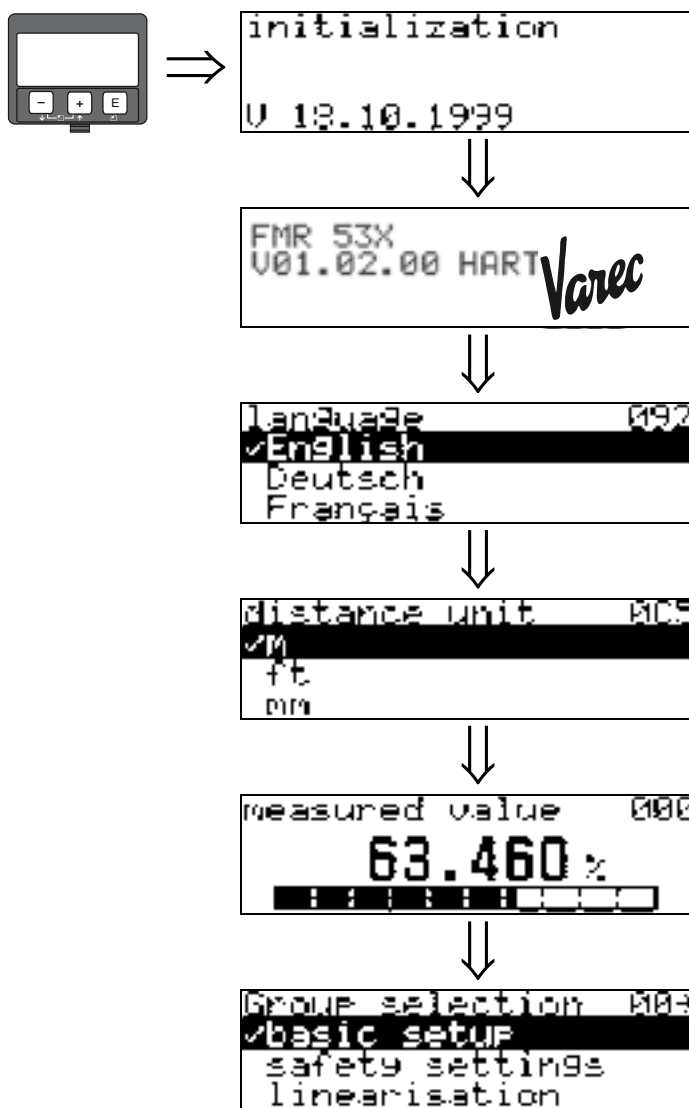
Make sure that all final checks have been completed before you start up your measuring point:

- Checklist "Post installation check" (see page 24).
- Checklist "Post connection check" (see page 30).

6.2 Commissioning

6.2.1 Switching on the measuring device

When the instrument is switched on for the first time, the following messages appear on the display:



After 5 s, the following message appears

After 5 s or after you have pressed the following message appears

Select the language
(this message appears the first time the instrument is switched on)

Select the basic unit
(this message appears the first time the instrument is switched on)

The current measured value is displayed

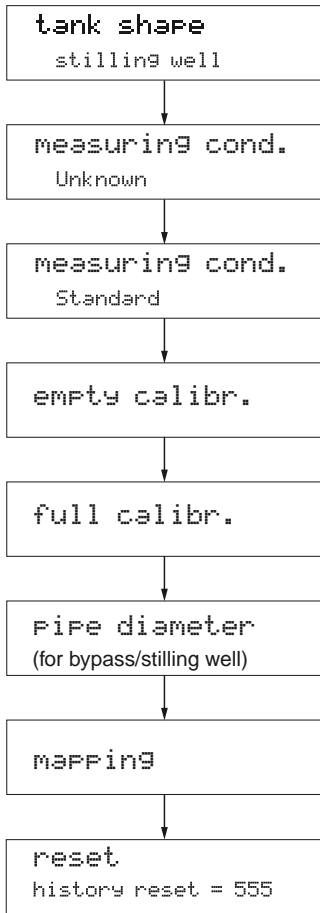
After is pressed, you reach the group selection.

This selection enables you to perform the basic setup

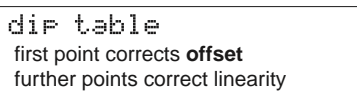
6.3 Basic Setup

Commissioning

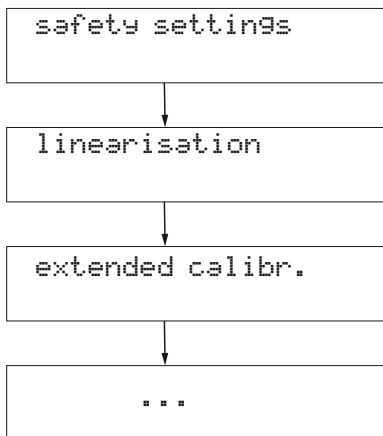
basic setup (standard)



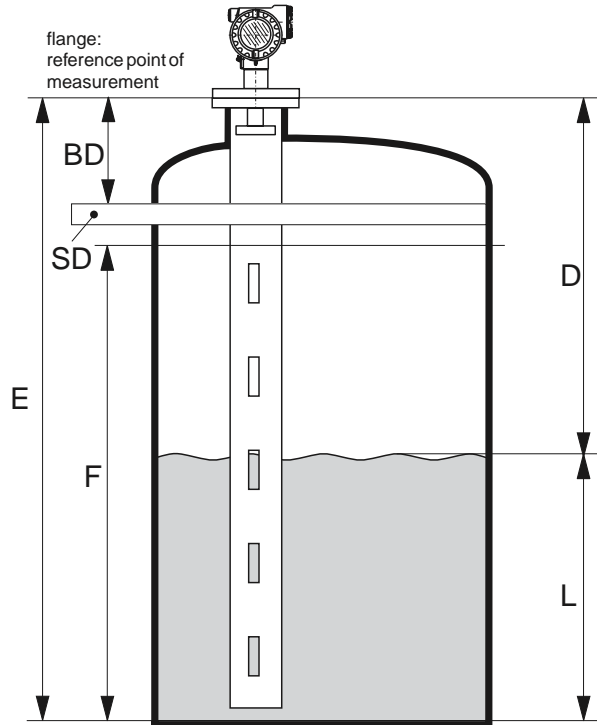
mounting
calibr.



option

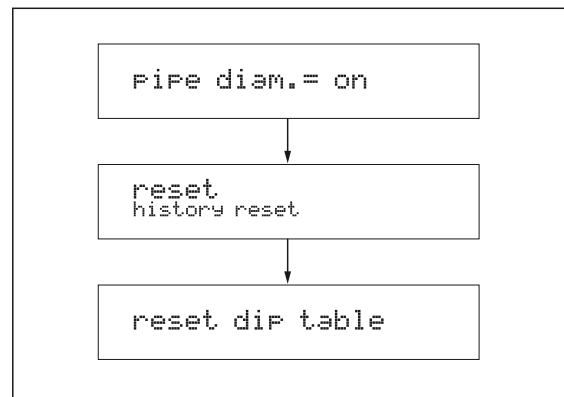


(description see BA 217F)



- E = empty calibr. (= zero) settings in 005
- D = distance (distance flange / product) display in 0A5
- SD = safety settings settings in 015
- F = full calibr. (= span) settings in 006
- L = level display in 0A6
- BD = blocking dist. settings in 059

Automatic pipe diameter correction (option)



L00-FMR532xx-19-00-00-en-003

To successfully commission a precise measurement to the nearest mm, it is important you carry out a **history reset** on **first installation** after mechanical installation and **after** the basic setup of the device (see Page 56). Only after a history reset the **mounting calibration** is carried out. Enter the measurement **offset** as the first point in the dip table for the mounting calibration. When a value is dipped at a later date, make a second entry into the dip table, again using the semi-automatic mode. This way, you can easily carry out a **linearization** of the measurement.

When configuring the function in "**basic setup**" (00) please take into account the following notes:

- Select the functions as described on page 31.
- Some functions can only be used depending on the parameterization of the instrument. For example, the pipe diameter of a stilling well can only be entered if "**stilling well**" was selected beforehand in the "**tank shape**" (002) function.
- Certain functions (e.g. starting an interference echo mapping (053)) prompt you to confirm your data entries. Press + or - to select "YES" and press E to confirm. The function is now started.
- If you do not press a key during a configurable time period (→ function group "display (09)"), an automatic return is made to the home position (measured value display).

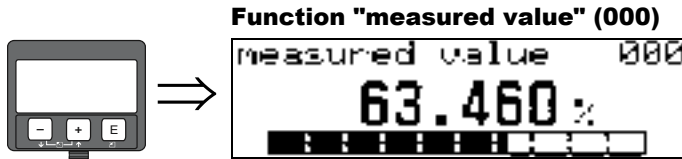
Note!

- The instrument continues to measure while data entry is in progress, i.e. the current measured values are output via the signal outputs in the normal way.
- If the envelope curve mode is active on the display, the measured values are updated in a slower cycle time. Thus, it is advisable to leave the envelope curve mode after the measuring point has been optimized.
- If the power supply fails, all preset and parameterized values remain safely stored in the EEPROM.

Note!

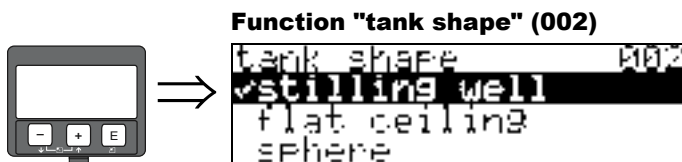
All functions are described in detail, as is the overview of the operating menu itself, in the 7500 RTG "Service manual and description of instrument functions".

6.4 Basic Setup with the VU 331



This function displays the current measured value in the selected unit (see "customer unit" (042) function). The number of digits after decimal point can be selected in the "no.of decimals" (095) function. The length of the bargraph corresponds to the percentile value of the present measured value with regard to the span.

6.4.1 Function group "basic setup" (00)



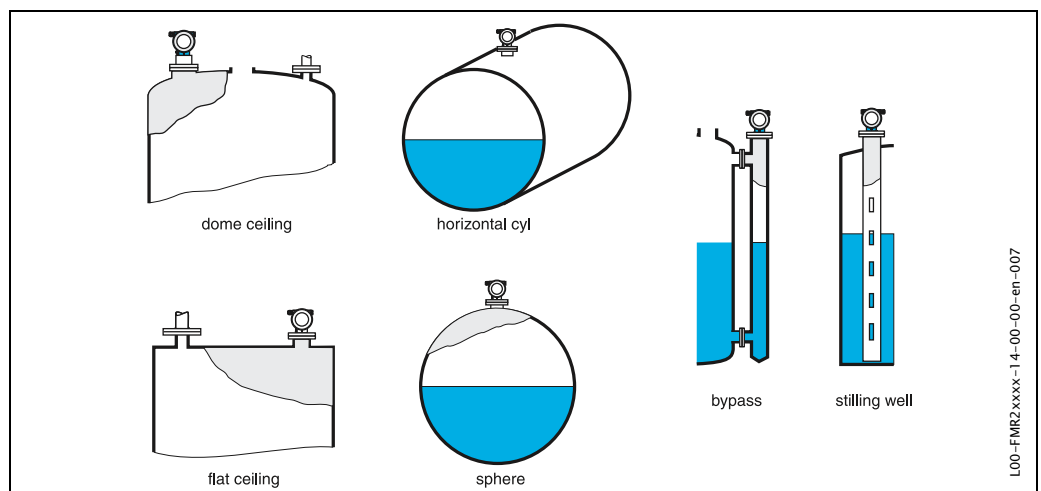
This function is used to select the tank shape.

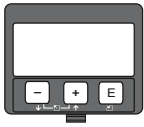
Note!

For the application of the 7532 RTG the selection "stilling well" has to be chosen in the function "tank shape" (002).

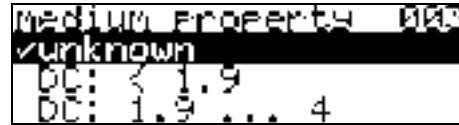
Selection:

- dome ceiling
- horizontal cyl
- bypass
- **stilling well**
- flat ceiling (Typical ceiling of storage tanks: a slight slope of only a few degrees can be neglected.)
- sphere





Function "medium property" (003)



This function is used to select the dielectric constant.

Selection:

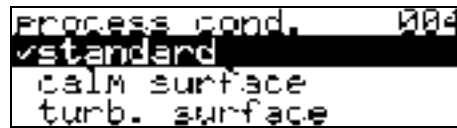
- unknown
- < 1.9
- 1.9 ... 4
- 4 ... 10
- > 10

Product class	DK (\hat{V}_r)	Examples
A	1,4 ... 1,9	non-conducting liquids, e.g. liquefied gas ³⁾
B	1,9 ... 4	non-conducting liquids, e.g. benzene, oil, toluene, ...
C	4 ... 10	e.g. concentrated acids, organic solvents, esters, aniline, alcohol, acetone, ...
D	> 10	conducting liquids, e.g. aqueous solutions, dilute acids and alkalis

³⁾Treat Ammonia NH₃ as a medium of group A, i.e. always use a stilling well.



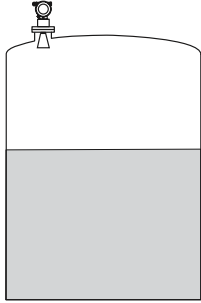
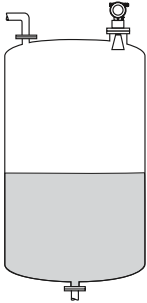
Function "process cond." (004)



This function is used to select the process conditions.

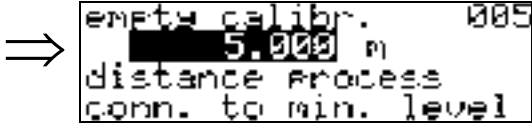
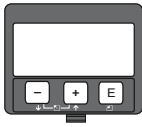
Selection:

- **standard**
- calm surface
- turb. surface
- agitator
- fast change
- test:no filter

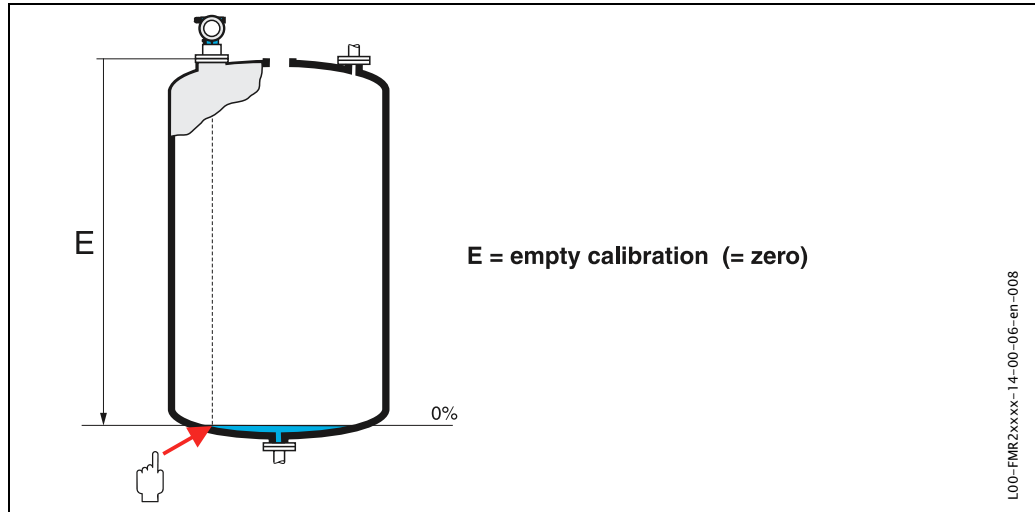
standard	calm surface
For all applications that do not fit into any of the following groups.	Storage tanks with immersion tube or bottom filling
	
The filter and output damping are set to average values.	The averaging filters and output damping are set to high values. -> steady meas. value -> precise measurement -> slower reaction time

Note!

The phase evaluation of the 7500 RTG (see »Function "auto-correction" (031)« on page 57) is only activated if you select the measuring conditions "**standard**" or "**calm surface**". We strongly recommend that, in the case of rough product surfaces or rapid filling, you activate the appropriate application parameters.



This function is used to enter the distance from the flange (reference point of the measurement) to the minimum level (=zero).

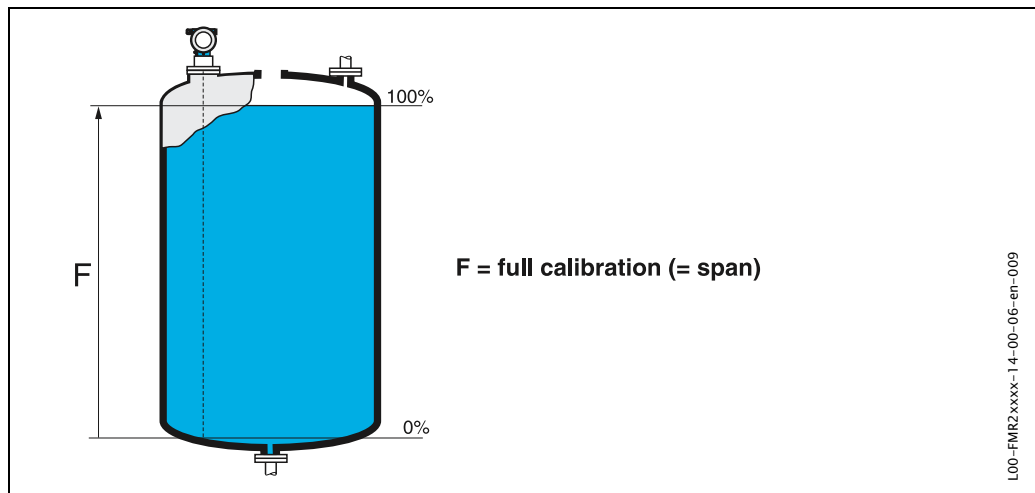


Caution!

For dish bottoms or conical outlets, the zero point should be no lower than the point at which the radar beam hits the bottom of the tank.



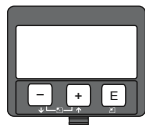
This function is used to enter the distance from the minimum level to the maximum level (=span).



In principle, it is possible to measure up to the tip of the antenna. However, due to considerations regarding corrosion and build-up, the end of the measuring range should not be chosen any closer than 50 mm (2") to the tip of the antenna.

Note!

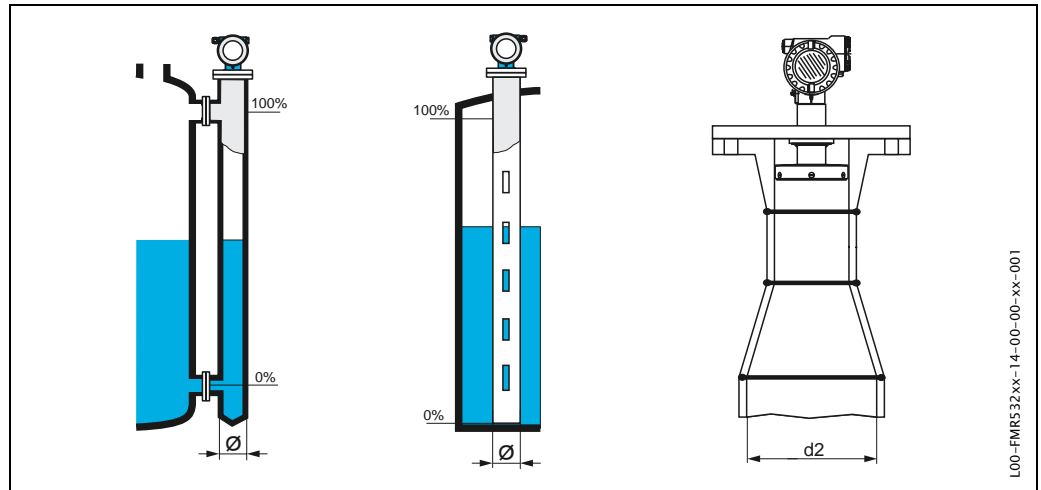
If **bypass** or **stilling well** was selected in the "tank shape" (002) function, the pipe diameter is requested in the following step.

Function "pipe diameter" (007)

```

Pipe diameter: 007
204.425 mm
inner diameter of
bypass/stilling well
  
```

This function is used to enter the pipe diameter of the stilling well or bypass pipe.



Microwaves propagate slower in pipes than in free space. This effect depends on the inside diameter of the pipe and is automatically taken into account by the 7500 RTG. It is only necessary to enter the pipe diameter for applications in a bypass or stilling well. If mounting the 7532 RTG on stilling wells with a widening of the pipe, the **inner** diameter of the lower part of the pipe (d2 in the Fig.) must be entered. This is the part of the stilling well, where the measurement is actually performed.

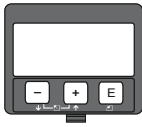
Function "dist./ meas. value (008)"

```

dist./meas.value 008
dist. 2.463 m
meas.v. 63.422 %
  
```

The **distance** measured from the reference point to the product surface and the **level** calculated with the aid of the empty adjustment are displayed. Check whether the values correspond to the actual level or the actual distance. The following cases can occur:

- Distance correct - level correct -> continue with the next function, "**check distance**" (051)
- Distance correct - level incorrect -> Check "**empty calibr.**" (005)
- Distance incorrect - level incorrect -> continue with the next function, "**check distance**" (051)



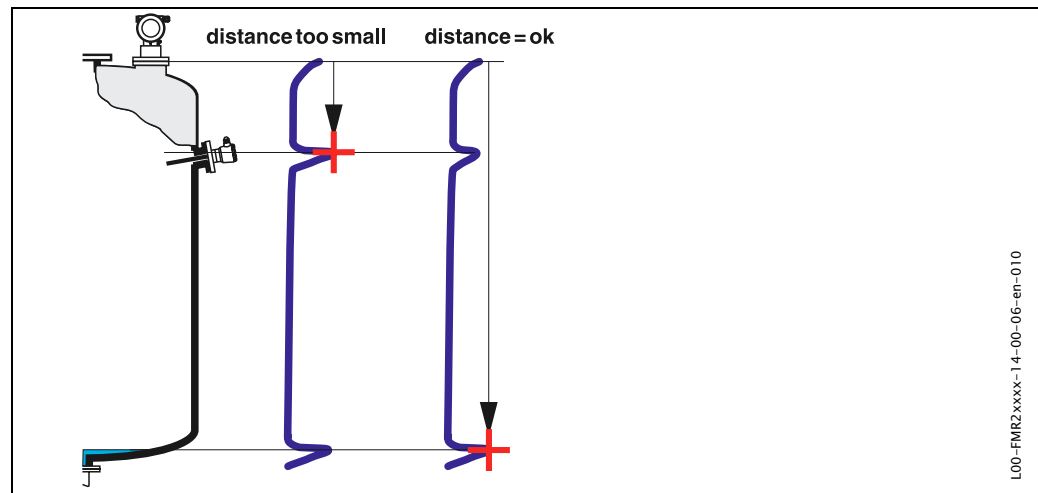
Function "check distance" (051)

```
check distance 051
dist. unknown
manual
distance = ok
```

This function triggers the mapping of interference echoes. To do so, the measured distance must be compared with the actual distance to the product surface. The following options are available for selection:

Selection:

- distance = ok
- dist. too small
- dist. too big
- **dist. unknown**
- manual



distance = ok

- mapping is carried out up to the currently measured echo
- The range to be suppressed is suggested in the "**range of mapping (052)**" function. Anyway, it is wise to carry out a mapping even in this case.

dist. too small

- At the moment, an interference is being evaluated
- Therefore, a mapping is carried out including the presently measured echoes
- The range to be suppressed is suggested in the "**range of mapping (052)**" function

dist. too big

- This error cannot be remedied by interference echo mapping
- Check the application parameters **(002)**, **(003)**, **(004)** and "**empty calibr.**" **(005)**

dist. unknown

If the actual distance is not known, no mapping can be carried out.

manual

A mapping is also possible by manual entry of the range to be suppressed. This entry is made in the "**range of mapping (052)**" function.

Caution!

The range of mapping must end 0.5 m (20") before the echo of the actual level. For an empty tank, do not enter E, but E - 0.5 m (20").



Function "range of mapping" (052)

```

range of mapping 052
  0.000 m
input of
mapping range
  
```

This function displays the suggested range of mapping. The reference point is always the reference point of the measurement (see page 46). This value can be edited by the operator.

For manual mapping, the default value is: 0 m.



Function "start mapping" (053)

```

start mapping 053
  off
  on
  
```

This function is used to start the interference echo mapping up to the distance given in "range of mapping" (052).

Selection:

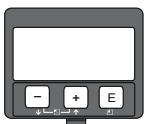
- **off:** no mapping is carried out
- **on:** mapping is started

**Display "dist./meas.value (008)"**

```
dist./meas.value 008
dist.      2.463 m
meas.v.    63.422 %
```

The distance measured from the reference point to the product surface and the level calculated with the aid of the empty alignment are displayed again. Check whether the values correspond to the actual level or the actual distance. The following cases can occur:

- Distance correct - level correct -> basic setup completed
- Distance incorrect - level incorrect -> a further interference echo mapping must be carried out "check distance" (051).
- Distance correct - level incorrect -> check "empty calibr." (005)

**Function "history reset" (009)**

```
history reset 009
✓hd
yes
```

By this function a history reset of the device is performed, i.e. the correspondence table between level and index values is deleted. A new correspondence table will be filled and stored after the history reset, see page 57.

Caution!

Perform only after first installation (see »Function "auto-correction" (031)« on page 57). In this case also effect a reset of the dip table in function "dip table mode" (033).



```
Return to
Group Selection
```



```
GROUP selection 003
✓basic setup
safety settings
linearisation
```

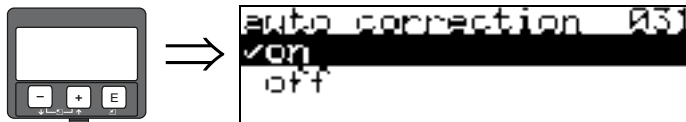
After 3 s, the following message appears

Note!

After basic calibration, it is wise to evaluate the measurement using the envelope curve (function group "display" (09)).

6.5 Mounting calibration with VU 331

6.5.1 Function group "mounting calibr." (03)



Using this function, you can either enter a dip table or carry out an auto-correction.

Function "auto-correction" (031)

When measuring levels with radar systems, so-called "multipath reflections" can affect the level signal giving rise to serious measuring errors. "Multipath reflections" also include radar beams which are received by the radar system, which have not been reflected directly by the medium surface. They may reach the antenna via the basin wall and the medium surface. This phenomenon is particularly noticeable with devices mounted near to walls, as soon as the conical radar beam strikes the basin wall. The 7500 RTG can automatically discover and correct measuring errors due to this "multiple path" propagation. This is because it uses two independent sets of information when evaluating reflection signals:

- Firstly, it evaluates the **amplitude** of the reflected energy using the so-called envelope curve system.
- Secondly, it evaluates the **phase** of the reflected energy.

The decisive factor for a constant output signal is to assign the phase values to the associated level values. This assignment is ensured using a correspondence table (index correction table). The 7500 RTG learns this for the specific application after installation (learning period).

Therefore, after mounting the device, and **after** completing the basic calibration, a **history reset** must be performed (enter "yes" in the "history reset" (009) function in the "basic setup" (00) function group).

Do not switch off the radar system during filling and emptying operations during the teach-in phase. Switching off when there are only negligible level changes produces no error.



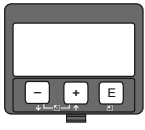
Caution!

During the learning period, fast filling/emptying or turbulent surfaces can result in switching off and on the phase evaluation. Subsequently observed measurement errors will disappear as soon as tank levels come back to areas measured by 7500 RTG previously with activated phase evaluation. If the observed measurement errors are cured by dip table entries, the 7500 RTG will take care of these corrections and automatically adjust the index correction table. Do **NOT** correct any settings in the basic calibration or the extended calibration.

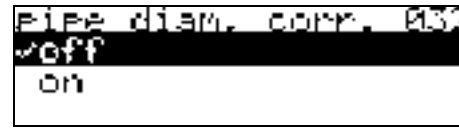
Note!

Immediately after installation, the 7500 RTG measures with the specified mm-accuracy. Until the level range has been completely covered by the medium (setting up the

correction table), the maximum permissible filling speed is 100 mm level change / min. After this, the fill speed has no limitation.



Function "pipe diam. corr." (032)

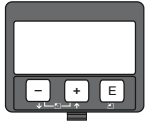


For level measurement in stilling wells, radar systems require highly precise pipe inner diameter data. An mm-exact level measurement cannot be guaranteed for deviations from the actual stilling well inner diameter of more than ± 0.1 mm to the value entered in the function group "**basic setup**" (00). The errors which occur as a result are linear and can be corrected with a dip table containing at least two entries.

The 7500 RTG also has an automatic pipe inner diameter correction. This adjusts the entered stilling well inner diameter (input in the function group "**basic setup**" (00)) to the actual values. However, this presupposes that the value entered in the function group "**basic setup**" (00) matches the actual pipe inner diameter accurately as possible. The user-defined value entered in the function group "**basic setup**" (00) can be corrected with this value. In order to do this, switch on the "**pipe diam. corr.**" (032) function, after a level change **of at least 5 m** has occurred since start-up. The pipe diameter, which the instrument determines automatically, will then be transmitted to the "**pipe diameter**" (007) function.

Note!

Only if the "**pipe diameter**" (007) function has changed its value, it is necessary to perform a "**history reset**" (009) and to delete the dip table after activation of the "**pipe diam. corr.**" (032) function. Otherwise the level change of 5 m has not yet been exceeded. The "**pipe diam. corr.**" (032) function must be deactivated again and the procedure should be repeated at a later point of time.



Display "custody mode" (0A9)

```

custody mode 0A9
✓inactive
  active pos.
  active neg.
  
```

This indicates the instrument calibration mode. The calibration mode (active) can be set using the hardware security lock on the electronics (see Page 34).

Selection:

- inactive
- active pos.
- active neg.

active pos.

The custody mode (instrument is lead-sealed and accurate to the nearest mm) is active and is held.

active neg.

Custody mode (instrument is lead-sealed and accurate to the nearest mm) is activated and not held, e.g. because the signal-to-noise ratio is less than 10 dB (refer to function "echo quality" (056) in the function group "extended calibr." (05)).

Caution!

After entering all the values and completing mounting and aligning work, enter the Reset Code "555" in the function "history reset" (009) of the "basic setup" (00) function group to reset the instrument history for auto-correction.

Dip table

The dip table is used to correct the level readings of the 7500 RTG using independently taken hand dips. The dip table is used in particular to adapt the level gauge to the specific application conditions as mechanical offset and tank/stilling well design. Depending on national regulations, national inspectors will dip the tank at one to three levels during a calibration run and check the level readings.

Only one value pair must be entered into the dip table to correct the measurement **offset**.

If a second value pair is entered into the dip table, the 7500 RTG accepts the corrected measured values identically for both value pairs. All other measured values are determined by linear extrapolation.

If you enter more than two value pairs, the system carries out a linear interpolation between adjacent value pairs. Outside these value pairs, extrapolation is also linear.

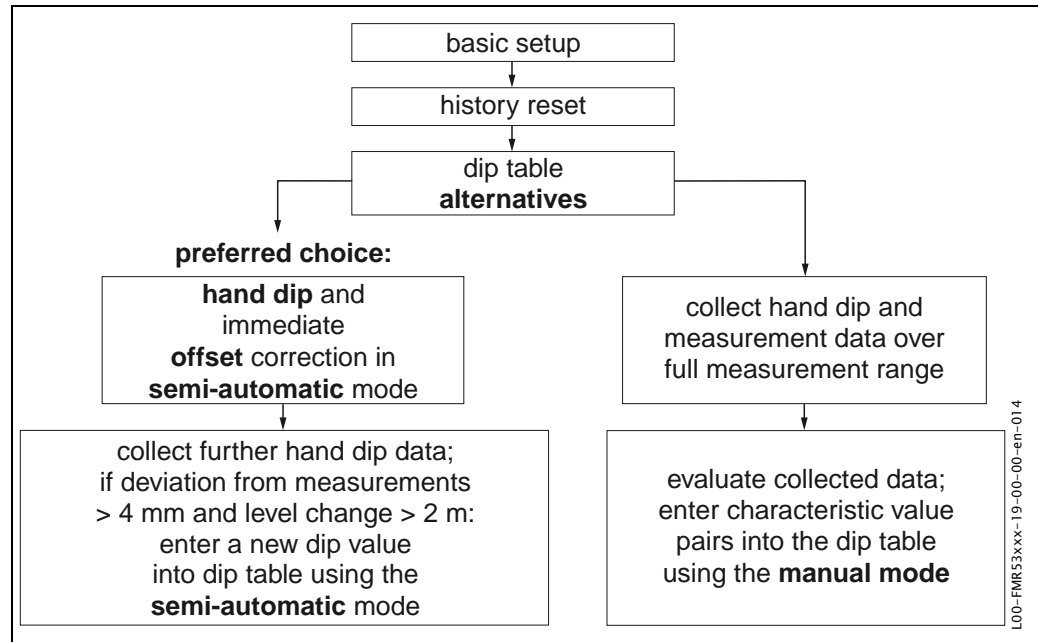


Figure 8: Alternative procedures to fill the dip table.

To collect and enter data into the dip table, two alternative procedures may be carried out. In order not to mix up measurement values corrected by the offset or linearization of the dip table with uncorrected measurement values, it is recommended to use the semi-automatic mode of the dip table to enter new data pairs. In this case, the first dip value should be entered immediately after the basic calibration. Further linearization points should be entered only after a level change of at least 2 m (see Figure 8:, preferred choice) and a deviation between the "uncorrected measurement value" and the hand dip value of at least 4mm.

If this procedure can not be followed, then **NO** value pair should be entered into the dip table after basic calibration. Measurement data and hand dip values should be collected over the full measurement range and be evaluated with regard to a good linear fit. Only then characteristic value pairs should be entered into the dip table using the "manual mode" (see Figure 8:, right side). If further linearization is needed, further hand dip values should be entered **using only the "semi-automatic mode"**.

Note!

The offset should NOT be determined and entered within the close range of the antenna (conf. definition of the safety distance) or immediately in the range of the tank bottom, because within these ranges interferences of the radar signal may occur.

Note!

The dip table can be printed out using the ToF-Tool. Before doing this, the ToF Tool must be reconnected to the instrument in order to update the values within the ToF Tool.

Note!

Make your inputs into the dip table in semi-automatic mode. We advise you to leave "auto correction" (031) activated ("on") while you enter your inputs.

Caution!

After entering one or more points into the dip table, make sure that the dip table is activated and left in the "table on" dip table mode.

**Function "dip table state" (037)**

```
dip table state 037
√table off
table on
```

This function displays the dip table status.

Display:

- table on
- **table off**

table on

Indicates whether the dip table is active.

table off

Indicates whether the dip table is not active.

**Function "dip table mode" (033)**

```
dip table mode 033
√table off
clear table
view
```

The dip table can be switched on or off using this function.

Selection:

- manual
- semi-automatic
- table on
- **table off**
- clear table
- view

manual

The value pairs in the dip table can be read and written. You can enter the measured value and the dip value.

-uncorrected measured value:

This is the measured value supplied by the instrument, **NOT** corrected by the dip table. The choice of measured value, level or remaining fill height is dependent on the instrument setting.

-Dip value:

This is the level or distance to flange respectively, given by the hand dip. This value should be used to correct the measured value.

The "manual mode" of the dip table can be used to enter collected data after a series of data pairs taken at different tank levels.

Note!

The bigger the distance between the different levels while taking hand dips, the more accurate the linearization of the dip table will be.

semi-automatic

The value pairs in the dip table can be read. You can enter the dip value only. When there are new value pairs, the current level or distance is accepted as the measured value.

table on

The dip table is switched on.

table off

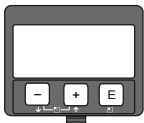
The dip table is switched off.

clear table

The complete dip table is deleted. The table is switched off. The number of free table entries is set to the maximum value (= 32).

View

The value pairs in the dip table can **only** be read. You can still select this menu option, even if there is no dip table available. In this case, the number of free table entries is at maximum value (= 32).

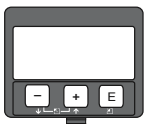
Function "dip table" (034)

```
dip table 034
meas.v. 40.000m
dip val 40.000m
remain. 32
```

This function edits measured variable. The number behind the entry "**remain**" indicates the current number of remaining free value pairs. The maximum number of value pairs is 32; after each entry, the remaining number is decremented.

Note!

The uncorrected measured value is displayed in the "dip table" (034) function. This may differ considerably from the measured values when a dip table is activated.

Function "dip table" (035)

```
dip table 035
meas.v. 40.000m
dip val 40.000m
remain. 32
```

This function edits the dip value.



Function "dip table handl." (036)

```
dip table handl. 036
✓new point
edit point
store point
```

Use this function to enter the dip value (level or distance) which will correct the measurement values.

Selection:

- **new point**
- edit point
- store point
- delete point
- return
- next point
- previous point

General procedure:

To enter a new point into the dip table, use "**new point**" to enter the value (pairs), "**store point**" to sort the new value (pairs), "**return**" to go to the dip table mode and "**table on**" to activate the dip table.

new point

You can enter a new point. A suggested value is displayed for the measured variable, the dip value of the current level or the distance. With semi-automatic inputs, the current level or the current remaining fill height is displayed as proposed dip value. The new value pair can be altered without selecting the "**edit point**" parameter.

If the table is full, you can still select this parameter. In this case, the number of free table entries stands at minimum value (= 0).

edit point

The displayed value pair can be changed. Only the dip value can be changed with semi-automatic input mode.

Caution!

To accept the value pair in the table, confirm it with "**store point**".

store point

The displayed value pair is sorted in the table.

Note!

For sorting, the following criteria must be met:

- Measured variables may not be equal but have different dip values.
- A measured variable available in the table is recognized as equal when it is closer than 1 mm to the sorting value.
- After successful sorting, the setting remains at "**edit point**" and the number of free table entries is decremented.

Caution!

If the value cannot be sorted, the setting remains at the previous menu option. No warning or error message is generated. However, the number of remaining table entries is not decremented.

delete point

The currently displayed point is deleted from the table. After deletion, the previous point is displayed. If the table only consisted of one point before deletion, then the current measured variable is displayed as a value pair.

return

By selecting this point, you return to the function "**dip table mode**" (033).

next point

This scrolls down in the table. If the table is empty, you can still select this option. However, the displayed value does not change.

previous point

This scrolls up in the table. If the table is empty, you can still select this option. However, the displayed value does not change.

Caution!

After entering one or more points into the dip table, make sure that the dip table is activated in the "**table on**" dip table mode.

6.5.2 Envelope curve with VU 331

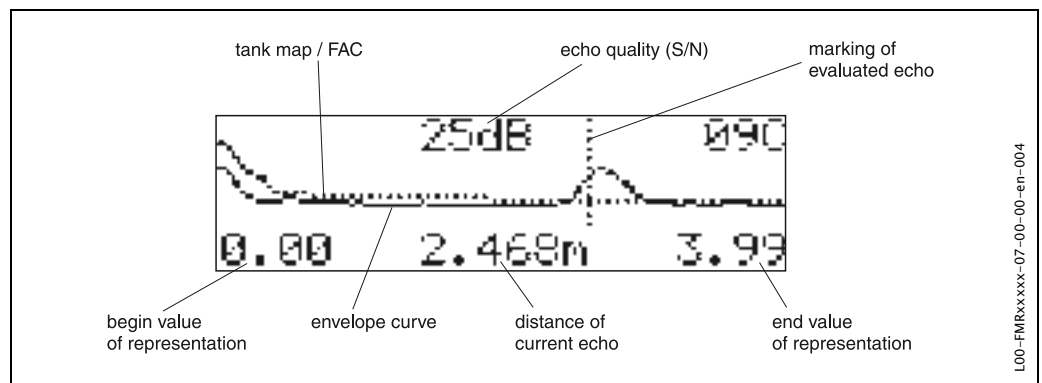
After the basic setup, an evaluation of the measurement with the aid of the envelope curve ("display" (09) function group) is recommended.

Function "plot settings" (09A)



Here you can select which information is shown on the display:

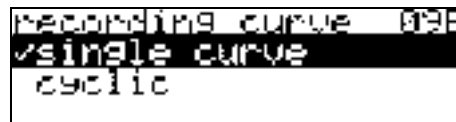
- envelope curve
- env. curve+FAC (for FAC see 7500 RTG "Service manual and description of instrument functions")
- env. curve+suppress. (i.e. the tank map is also displayed)



Function "recording curve" (09B)

This function determines whether the envelope curve is read as:

- single curve
- or
- cyclic



Note!

If the envelope curve mode is active on the display, the measured values are updated in a slower cycle time. Thus, it is advisable to leave the envelope curve mode after the measuring point has been optimized.

6.6 Basic Setup with the ToF Tool

To carry out the basic setup with the ToF Tool operating program, proceed as follows:

- Start the ToF Tool operating program and establish a connection
- Select the "**basic setup**" function group in the navigation bar

The following display appears on the screen:

Basic Setup step 1/5:

- Status image
- Enter the measuring point description (TAG number).



Note!

- Each parameter that is changed must be confirmed with the **RETURN** key!
- The "**Next**" button moves you to the next screen display:

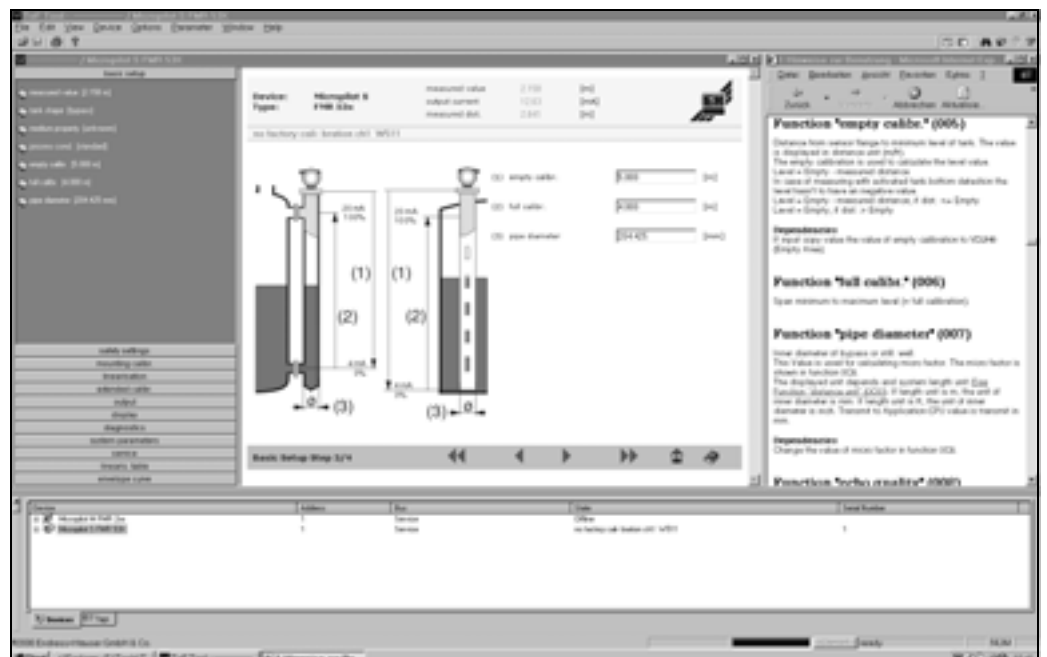
Basic Setup step 2/5:

- Enter the application parameters:
 - tank shape (for a description, see page 49)
 - medium property (for a description, see page 50)
 - process cond. (for a description, see page 51)

**Basic Setup step 3/5:**

If "stilling well" or "bypass" is selected in the "tank shape" function, the following display appears on the screen:

- empty calibr. (for a description, see page 52)
- full calibr. (for a description, see page 52)
- Diameter of bypass / stilling well (for a description, see page 53)

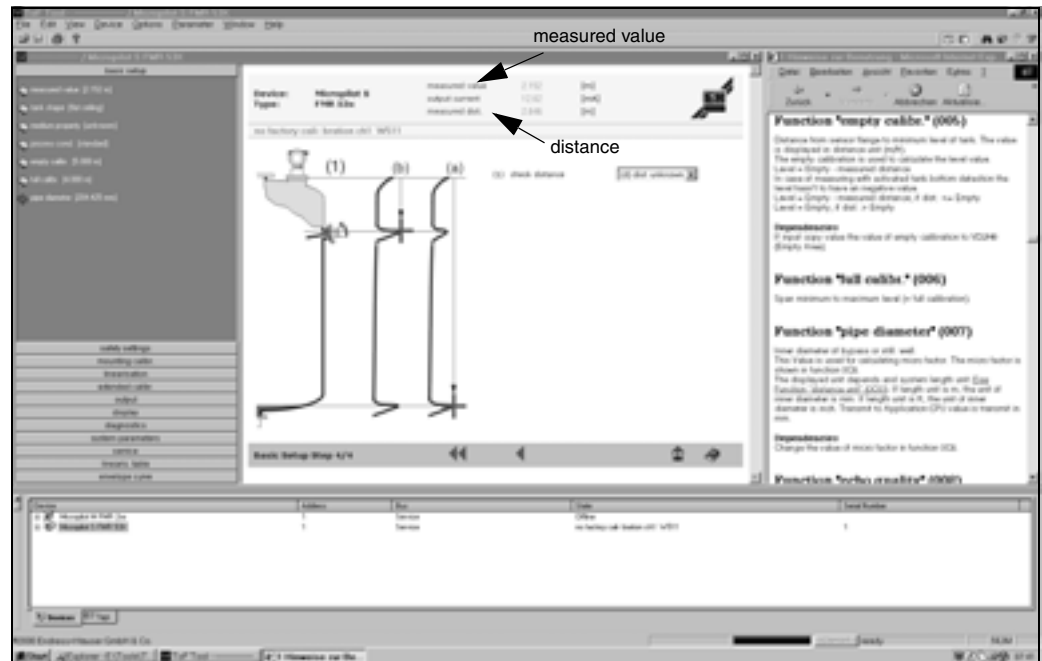


Note!

You can also specify the pipe diameter in this display.

Basic Setup step 4/5:

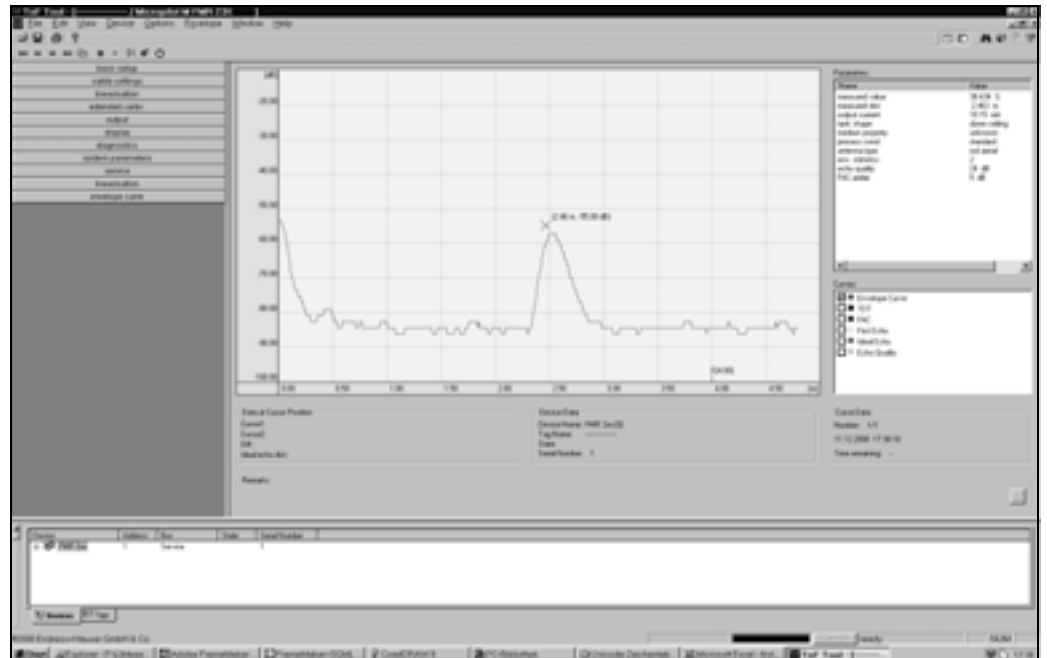
- This step starts the tank mapping
- The measured distance and the current measured value are always displayed in the header
- A description is given on page 56

**Step 5/5:**

After the first installation of the device, initialise the index correction table (compare page 57) by activating the history reset 555.

6.6.1 Envelope curve with the ToF Tool

After the basic setup, an evaluation of the measurement using the envelope curve is recommended.



6.6.2 User-specific applications (operation)

To set the parameters of user-specific applications, see the 7500 RTG "Service manual and description of instrument functions".

6.7 Mounting calibration with the ToF Tool

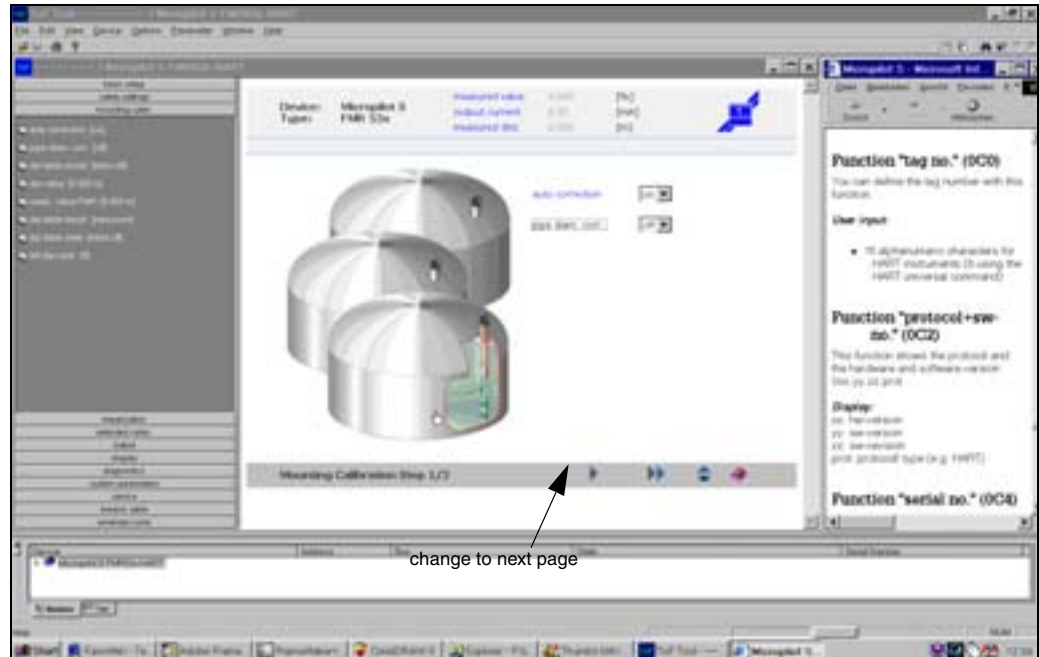
To carry out the basic setup with the ToF Tool operating program, proceed as follows:

- Start the ToF Tool operating program and establish a connection
- Select the "mounting calibr." function group in the navigation bar

The following display appears on the screen:

Mounting calibration step 1/2:

- auto correction (description see page 57)
- pipe diam. corr. (description see page 58)

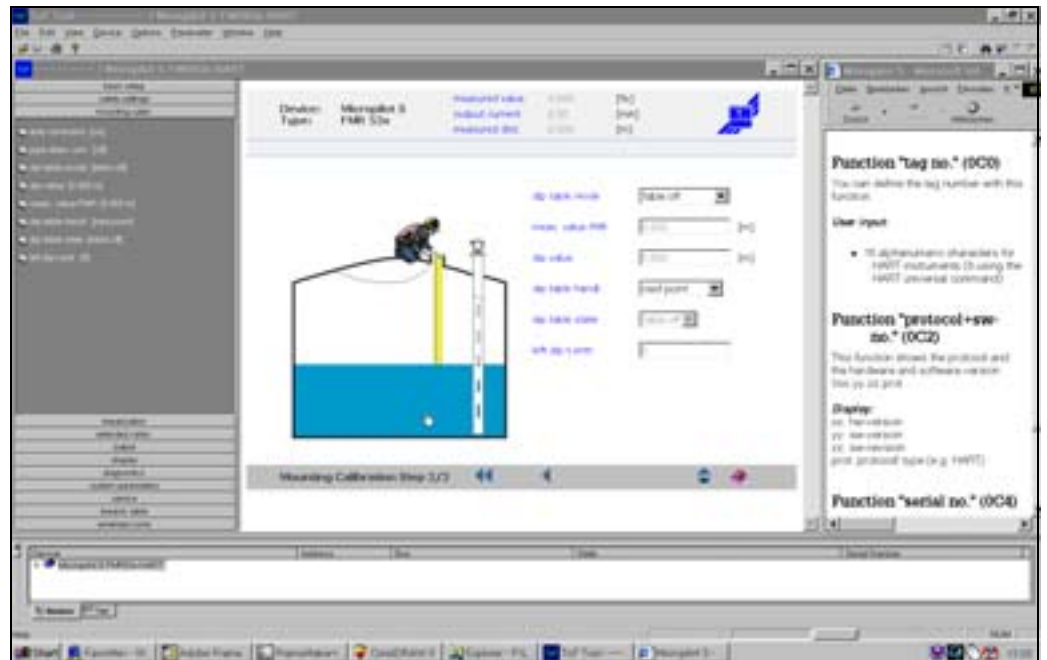


Note!

- Each parameter that is changed must be confirmed with the **RETURN** key!
- the "**Next**" button moves you to the next screen display:

Mounting calibration step 2/2:

- dip table mode (description see page 61)
- meas. v. (description see page 62)
- dip value (see page 62)
- dip table handl. (description see page 63)
- dip table state (description see page 61)
- left dip t.ent. (description see page 61)



7 Maintenance

The 7500 RTG measuring instrument requires no special maintenance.

Exterior cleaning

When cleaning the exterior of measuring devices, always use cleaning agents that do not attack the surface of the housing and the seals.

Replacement

After a complete 7500 RTG or electronic module has been replaced, the parameters can be downloaded into the instrument again via the communication interface. Prerequisite to this is that the data were uploaded to the PC beforehand using the ToF Tool / Commuwin II.

Measurement can continue without having to carry out a new setup.

- You may have to activate linearization
- You may need to record the tank map again

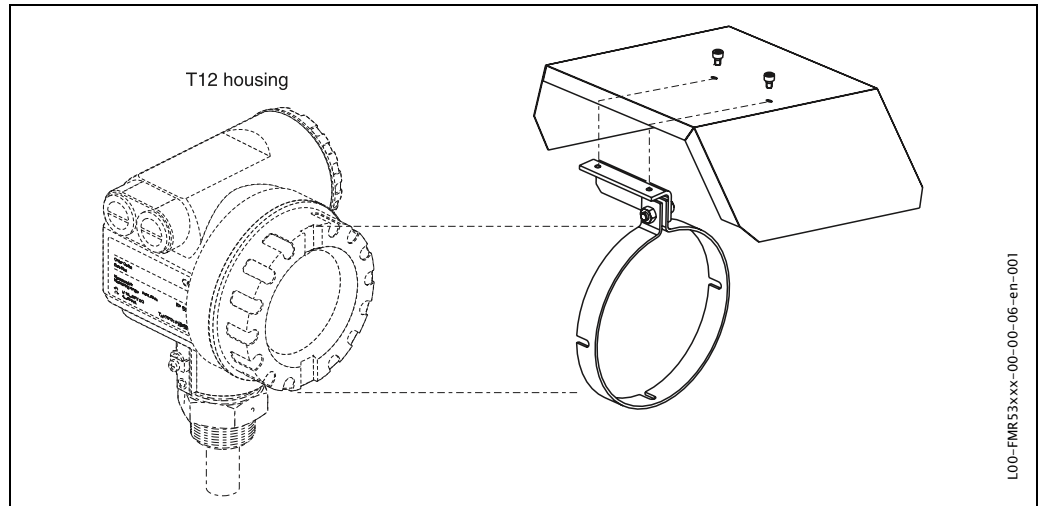
After an antenna component has been replaced, a new calibration must be carried out.

8 Accessories

Various accessories, which can be ordered separately from Varec, are available for the 7500 RTG.

Weather protection cover

A Weather protection cover made of stainless steel is available for outdoor mounting (order code: 543199-0001). The shipment includes the protective cover and tension clamp.



Commubox FXA 191 HART

For intrinsically safe communication with ToF Tool or Commuwin II via the RS 232C-interface.

Service adapter FXA 193

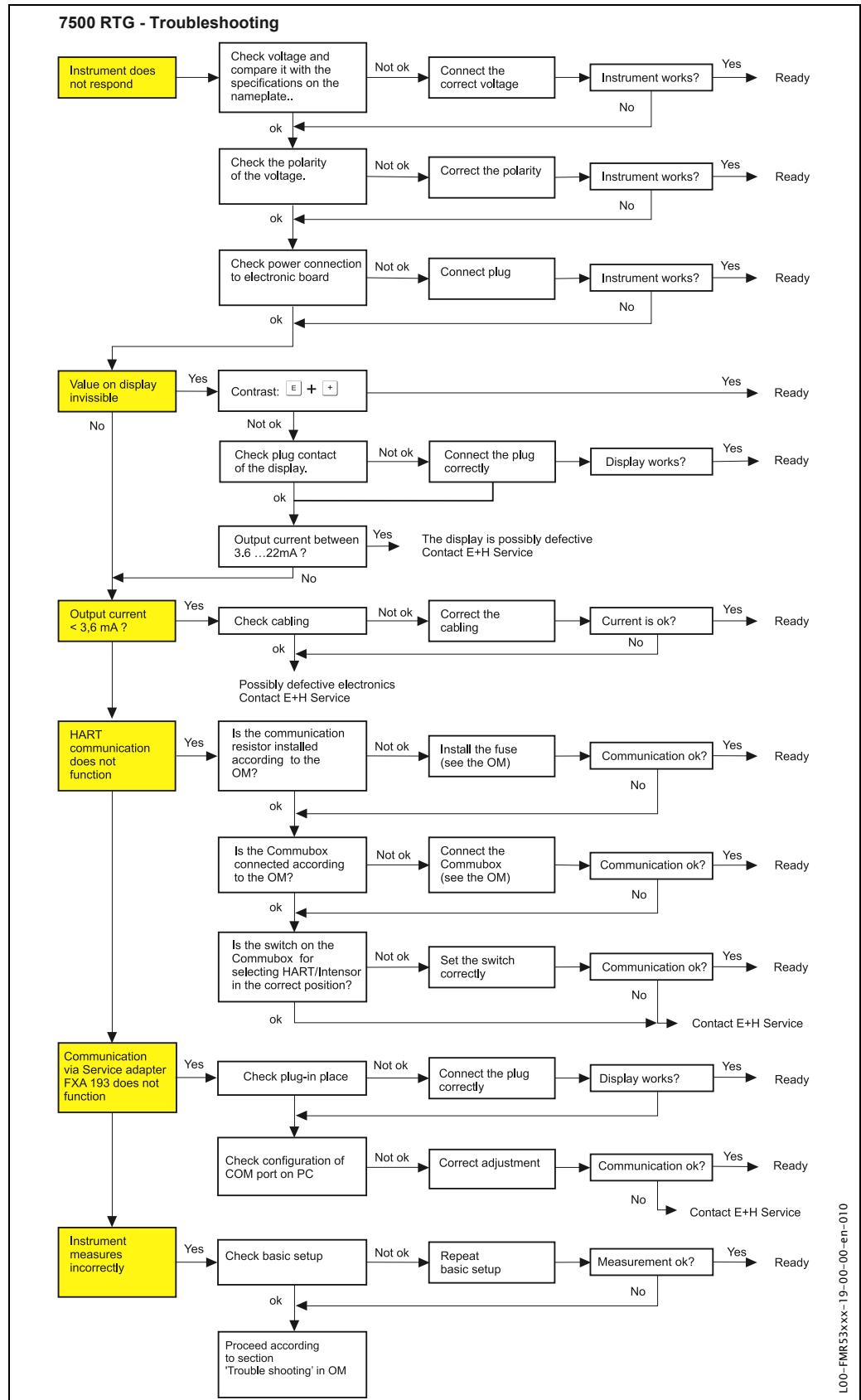
For communication with ToF Tool via the display connector. (Bestell-Nr.: 50095566).

Commuwin II

Operating software for intelligent instruments.

9 Troubleshooting

9.1 Troubleshooting instructions



L00-FMR53xxx-19-00-00-en-010

9.2 System error messages

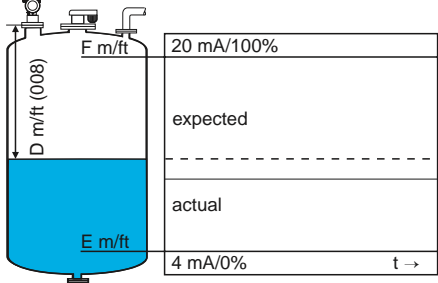
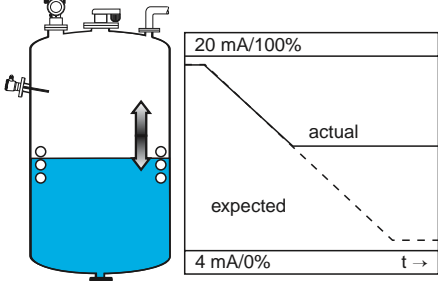
Code	Description	Possible cause	Remedy
A102	checksum error general reset & new calibr.required	device has been powered off before data could be stored; emc problem; E ² PROM defect	reset; avoid emc problem; if alarm prevails after reset, exchange electronics
W103	initialising – please wait	E ² PROM storage not yet finished	wait some seconds; if warning prevails, exchange electronics
A106	downloading please wait	processing data download	wait until warning disappears
A110	checksum error general reset & new calibr.required	device has been powered off before data could be stored; emc problem; E ² PROM defect	reset; avoid emc problem; if alarm prevails after reset, exchange electronics
A111	electronics defect	RAM defective	reset; if alarm prevails after reset, exchange electronics
A113	electronics defect	ROM defective	reset; if alarm prevails after reset, exchange electronics
A114	electronics defect	E ² PROM defective	reset; if alarm prevails after reset, exchange electronics
A115	electronics defect	general hardware problem	reset; if alarm prevails after reset, exchange electronics
A116	download error repeat download	checksum of stored data not correct	restart download of data
A121	electronics defect	no factory calibration existant; E ² PROM defective	contact service
W153	initialising – please wait	initialisation of electronics	wait some seconds; if warning prevails, power off device and power on again
A155	electronics defect	hardware problem	reset; if alarm prevails after reset, exchange electronics
A160	checksum error general reset & new calibr.required	device has been powered off before data could be stored; emc problem; E ² PROM defect	reset; avoid emc problem; if alarm prevails after reset, exchange electronics
A164	electronics defect	hardware problem	reset; if alarm prevails after reset, exchange electronics
A171	electronics defect	hardware problem	reset; if alarm prevails after reset, exchange electronics
A231	sensor 1 defect check connection	HF module or electronics defective	exchange HF module or electronics

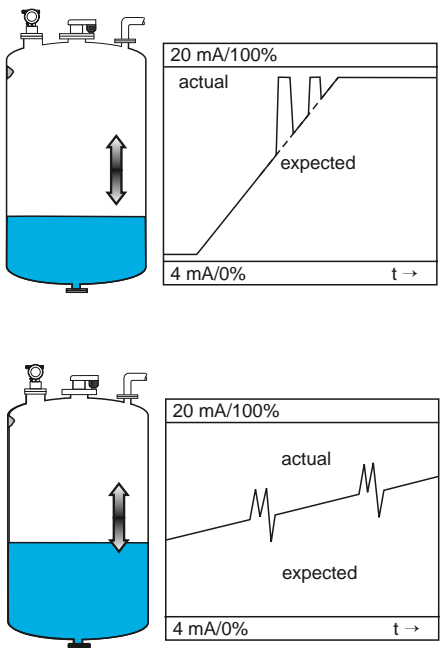
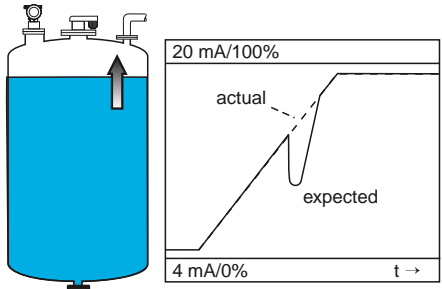
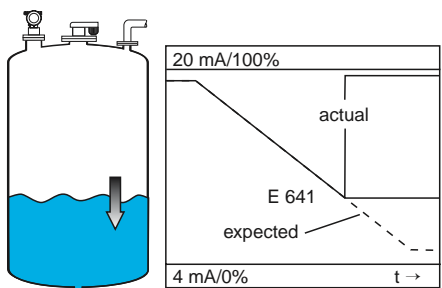


Table 3: System error messages

Code	Description	Possible cause	Remedy
A270	custody switch undef check position	switch for custody transfer may be defective	check position of custody switch exchange electronics
#		inconsistency between phase and amplitude evaluation inconsistent microfactor inconsistent index mapping	check basic calibration check mounting calibration check echo quality reset history "555" check stilling pipe diameter switch off autocorrection
A272	electronics defect amplifier	inconsistency in amplification	exchange electronics
W275	electronics defect factory setting	offset drift of A/D commuter	exchange electronics
W511	no factory calibration ch1	factory calibration has been deleted	record new factory calibration
A512	recording of mapping please wait	mapping active	wait some seconds until alarm disappears
W601	linearization ch1 curve not monotone	linearization not monotonously increasing	correct linearization table
W611	less than 2 linearization points for channel 1	number of entered linearization points < 2	correct linearization table
W621	simulation ch. 1 on	simulation mode is active	switch off simulation mode
E641	no usable echo channel 1 check calibr.	echo lost due to application conditions of built up on antenna	check installation; optimize orientation of antenna; clean antenna
E651	level in safety distance – risk of overspill	level in safety distance	alarm will disappear as soon as level leaves safety distance;
A671	linearization ch1 not complete, not usable	linearization table is in edit mode	activate linearization table
W681	current ch1 out of range	current out of range (3,8 mA ... 21,5 mA)	check calibration and linearization

Table 3: System error messages

9.3 Application errors

Error	Output	Possible cause	Remedy
<p>A warning or alarm has occurred.</p>	<p>Depending on the configuration</p>	<p>See table of error messages (see page 79)</p>	<p>1. See table of error messages (see page 79)</p>
<p>Measured value (00) is incorrect</p>	 <p>The diagram shows a tank with a level sensor. The sensor is labeled 'D m/ft (008)' and 'F m/ft'. The tank is partially filled with blue liquid. The sensor output is shown as a graph with '20 mA/100%' at the top and '4 mA/0%' at the bottom. The x-axis is labeled 't →'. A dashed line represents the 'expected' level, and a solid line represents the 'actual' level. The actual level is lower than the expected level.</p>	<p>Measured distance (008) OK? yes →</p> <p style="text-align: center;">no ↓</p> <p>Measurement in bypass or stilling well? yes →</p> <p style="text-align: center;">no ↓</p> <p>Is an FAR 10 antenna extension being used? yes →</p> <p style="text-align: center;">no ↓</p> <p>An interference echo may have been evaluated. yes →</p>	<p>1. Check empty calibr. (005) and full calibr. (006).</p> <p>2. Check linearization: → level/ullage (040) → max. scale (046) → diameter vessel (047) → Check table</p> <p>1. Is bypass or stilling well selected in tank shape (002)?</p> <p>2. Is the pipe diameter (007) correct?</p> <p>1. offset (057) correctly set?</p> <p>1. Carry out tank mapping → basic setup</p>
<p>No change off measured value on filling/emptying</p>	 <p>The diagram shows a tank with a level sensor. The sensor is labeled 'D m/ft (008)' and 'F m/ft'. The tank is partially filled with blue liquid. The sensor output is shown as a graph with '20 mA/100%' at the top and '4 mA/0%' at the bottom. The x-axis is labeled 't →'. A dashed line represents the 'expected' level, and a solid line represents the 'actual' level. The actual level is constant, while the expected level changes as the tank is filled or emptied.</p>	<p>Interference echo from installations, nozzle or extension on the antenna</p>	<p>1. Carry out tank mapping → basic setup</p> <p>2. If necessary, clean antenna</p> <p>3. If necessary, select better mounting position</p>

Error	Output	Possible cause	Remedy
<p>If the surface is not calm (e.g. filling, emptying, agitator running), the measured value jumps sporadically to a higher level</p>		<p>Signal is weakened by the rough surface — the interference echoes are sometimes stronger</p>	<ol style="list-style-type: none"> 1. Carry out tank mapping → basic setup 2. Set the process cond. (004) to "turb. surface" or "agitator" 3. Increase the output damping (058) 4. Optimize the orientation 5. If necessary, select a better mounting position and/or larger antenna
<p>During filling/emptying the measured value jumps downwards</p>		<p>Multiple echoes</p>	<p>yes →</p> <ol style="list-style-type: none"> 1. Check the tank shape (002), e.g. "dome ceiling" or "horizontal cyl" 2. In the range of the blocking dist. (059) there is no echo evaluation → Adapt the value 3. If possible, do not select central installation position 4. Perhaps use a stilling well
<p>E 641 (loss of echo)</p>		<p>Level echo is too weak. Possible causes:</p> <ul style="list-style-type: none"> • Rough surface due to filling/emptying • Agitator running • Foam 	<p>yes →</p> <ol style="list-style-type: none"> 1. Check application parameters (002), (003) and (004) 2. Optimize alignment 3. If necessary, select a better installation position and/or larger antenna
<p>E 641 (loss of echo) after turn on the power supply</p>	<p>If the instrument is configured to Hold by loss of echo the output is set to any value/current.</p>	<p>noise level during the initialisation phase to high.</p>	<p>Repeat once more empty calibr. (005). Caution! Before conformation change with  or  to the edit mode.</p>

9.4 Spare parts

Note!

You can order spare parts directly from your Varec service organization by giving the **order code** and the **serial number** which is printed on the measuring transducer nameplate (see page 7). The corresponding spare part number also appears on each spare part. Installation instructions are given on the instruction card that is also delivered.

Note!

If the calibration seal is broken, the national calibration authority should normally be informed within 24 hours.

Spare parts 7532 RTG
Housing T12 with separate wiring compartment

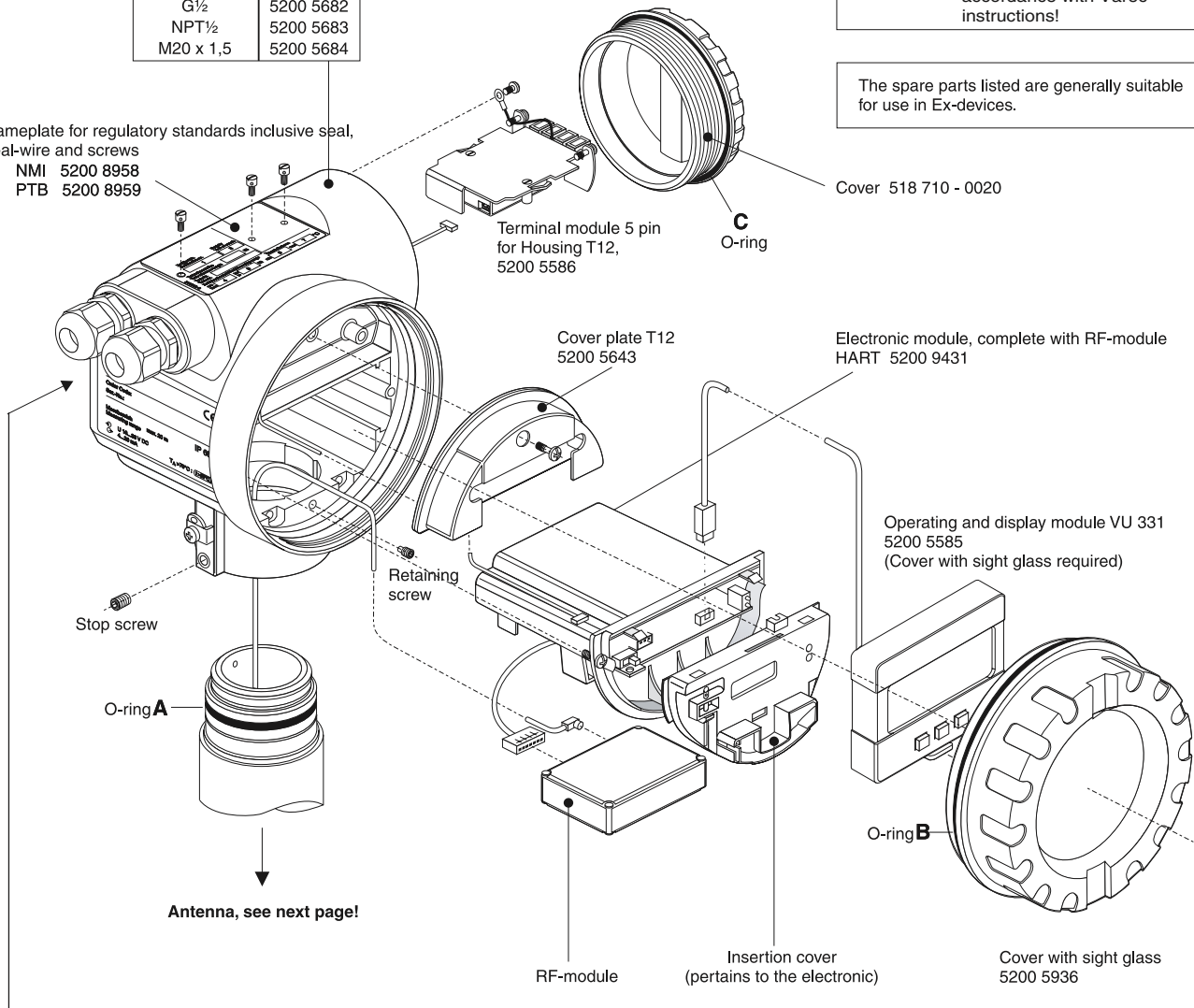
Housing T12
 complete pre-mounted without cover

Cable-gland/entry	Standard EEx ia
Pg13,5	5200 5681
G½	5200 5682
NPT½	5200 5683
M20 x 1,5	5200 5684

The customer may exchange modular assemblies in accordance with Varec instructions!

The spare parts listed are generally suitable for use in Ex-devices.

Nameplate for regulatory standards inclusive seal, seal-wire and screws
 NMI 5200 8958
 PTB 5200 8959



Antenna, see next page!

For using in Ex zones cable glands of the generation $\geq B$ must be required! Besides attention the permissible temperature area ($> 75^\circ C$).

Gasket set 5200 5628
 consist of:
 5 O-ring 49,21 x 3,53 EPDM, Pos. **A**
 5 O-ring 113,9 x 3,53 NBR, Pos. **B**
 5 O-ring 72,0 x 3,0 NBR Pos. **C**

L00-FMRS32x-00-00-06-en-001

Spare parts 7532 RTG
Planar antenna

Process connection without antenna

7532 RTG

detailed order structure and variants see spare parts price list

O-ring 49,21 x 3,53 EPDM (Seal set 52005628)

O-ring 85,32 x 3,53 FKM (green)
85,32 x 3,53 HNBR12-70 (black)

O-ring 49,21 x 3,53 EPDM (Seal set 52005628)

O-ring 85,32 x 3,53 FKM (green)
85,32 x 3,53 HNBR12-70 (black)

	Antenna size	Seal
5200 6193	DN 150 (6")	HNBR
5200 6332	DN 150 (6")	FKM
5200 6194	DN 200 (8")	HNBR
5200 6333	DN 200 (8")	FKM
5200 6195	DN 250 (10")	HNBR
5200 6334	DN 250 (10")	FKM

L00-FMR532xx-00-00-06-en-004

Modification nameplate

When ordering parts that are listed in the product structure (see page 8) , a check must be made as to whether the instrument description on the nameplate is still valid, e.g. for:

- an antenna component,
- an electronics module,
- an RF module,
- a VU 331 operating and display module,
- a housing cover with window.

Housing T12

The complete order code must be specified when ordering the replacement housing so that the correct nameplate can be delivered, e.g.

- 7532 RTG-AACWJAC1AA

You must label the nameplate yourself.

Caution!

- It is not possible to convert a standard instrument into an Ex instrument by simply exchanging parts.
- When repairing certified instruments, the relevant regulations must be followed.
- For FM approved instruments, it is forbidden to make any changes to the instrument that are not expressly authorized in the operating manual. Contravening this prohibition can invalidate the approval for operation of the instrument.

9.5 Return

If you need to send a 7500 RTG back to Varec for repair, please send a completed copy of the form printed on the last page.

- An exact description of the application.
- The chemical and physical characteristics of the product.
- A short description of the error that occurred.
- If necessary, give the error code.

Please carry out the measures described in section 1.4, “Return” on page 5 before sending a 7500 RTG back for repair.

9.6 Disposal

In case of disposal please separate the different components according to their material consistence.

9.7 Software history

Software version / Date	Software changes	Documentation changes
V 1.00.00 / 12.2000	Original software. Operated via: - ToF Tool - Commuwin II (from version 2.05.03) - HART communicator DXR 375 with Rev. 1, DD 1.	
V 01.02.00 / 03.2002	simplified commissioning history reset in basic calibration. Operated via: - ToF Tool (V3.0) - Commuwin II (from version 2.05.03) - HART communicator DXR 375 with Rev. 1, DD 1.	

10 Technical data

10.1 Technical data at a glance

Application	
<i>Application</i>	The 7500 RTG is used for highly accurate level measurement in storage tanks and can be applied in custody transfer applications. It meets the relevant requirements according to OIML R85 and API 3.1B. <ul style="list-style-type: none"> • The 7532 RTG with planar antenna is specifically and only suited for stilling well applications with ranges up to 38 m (124 ft).
Function and system design	
<i>Measuring principle</i>	The 7500 RTG is a "downward-looking" measuring system, operating based on the time-of-flight method. It measures the distance from the reference point (process connection) to the product surface. Radar impulses are emitted by an antenna, reflected off the product surface and received again by the radar system.
<i>Equipment architecture</i>	The 7500 RTG can be used for measurement in a stilling well as well as in free space. The different instrument versions are applied as follows: <ul style="list-style-type: none"> • The 7532 RTG with planar antenna is the preferred device in stilling wells ≥ 150 mm. • The instruments are equipped with a passive 4...20 mA output with HART protocol.
Input	
<i>Measured variable</i>	The measured variable is the distance between a reference point (mounting flange) and a reflective surface (e.g. medium surface). The measured value and all parameters are displayed using either metrical SI-units or US/UK-units (inch, ft, ...). The level is calculated based on the tank height entered. The level can be converted into other units (volume, mass) by means of a linearization. In order to compensate for non-linear effects like movement of the tank roof, an additional correction table (diptable) can be entered.
<i>Measuring range</i>	See page 15
Output	
<i>Output signal</i>	4...20 mA with HART protocol: this version can be operated via the PC operating software ToF Tool and Commuwin II. The instrument supports both point-to-point and multidrop operation.
<i>Signal on alarm</i>	Error information can be accessed via the following interfaces: <ul style="list-style-type: none"> • Local display: <ul style="list-style-type: none"> - Error symbol (see page 35) - Plain text display - LED's: red LED continuously on = alarm, red LED flashes = warning • Current output • Digital interface
<i>Galvanic isolation</i>	500 V towards ground. 500 V between power supply and signal

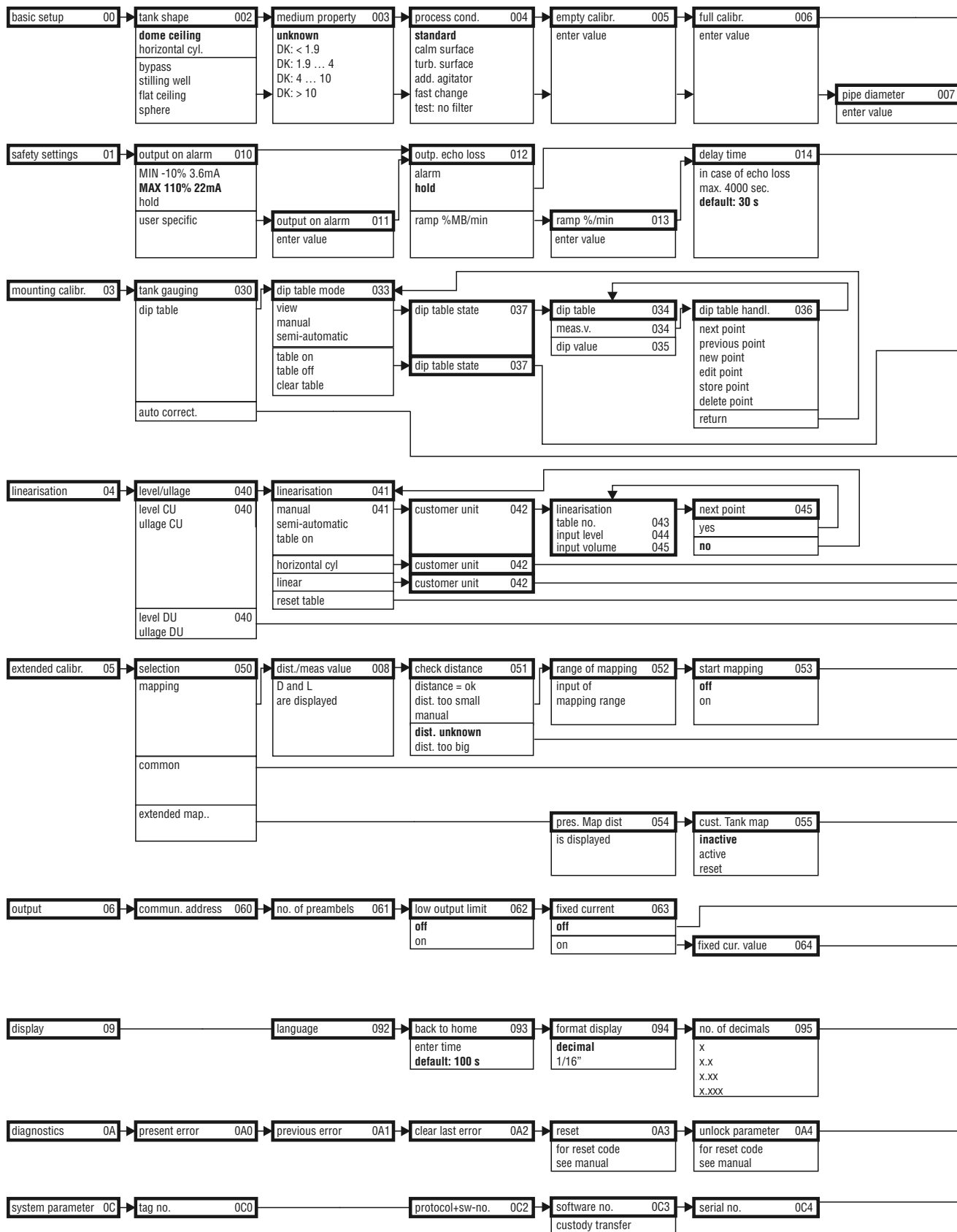
Auxiliary energy	
<i>Electrical connection</i>	Housing T 12 with separate terminal compartment.
<i>Load HART</i>	Minimum load for HART communication: 250 Ω
<i>Cable entry</i>	Cable gland: M20x1.5 or Pg1 3.5 Cable entry: G ½ or ½ NPT
<i>Supply voltage</i>	See page 28
<i>Power consumption</i>	Max. 330 mW at 16 V, max. 500 mW at 24 V, max. 600 mW at 30 V.
<i>Current consumption</i>	Max. 21 mA (50 mA inrush current).
<i>Power supply</i>	For stand alone operation recommended via e.g. Varec RN 221N/Z.
Performance characteristics	
<i>Reference operating conditions</i>	<p>According to OIML R85:</p> <ul style="list-style-type: none"> • Temperature = -25...+55 °C (-13...+131 °F) • Atmospheric pressure • Relative humidity (air) = 65 % ±15% • Medium properties: e.g. medium with good reflectivity and calm surface. • Tank diameter: signal beam hits the tank wall only at one side. <p>Note! No major interference reflections inside the signal beam.</p>
<i>Maximum measured error</i>	Absolute accuracy: 0.5 mm (2σ value) Inventory Control Versios: ±3 mm
<i>Proof of accuracy for custody transfer versions</i>	<p>The accuracy of each 7500 RTG is established through a calibration certificate that records the absolute and relative error at 10 equidistant points during the final test. For stilling well measurements with 7532 RTG, a NMI / PTB calibrated tape with an absolute accuracy of 0.25 mm is used.</p> <p>Each 7500 RTG is delivered with the PTB and NMi type approval. Additional initial factory verifications for custody applications are available on demand for all 7500 RTG.</p>
<i>Maximum fill speed</i>	By the first pass trough of measuring range: 100 mm/min., after it unlimited.
<i>Non-repeatability</i>	0,3 mm (1/64")
<i>Hysteresis</i>	0.3 mm
<i>Resolution</i>	digital: 0.1 mm analogue: 0.03 % of measuring range
<i>Settling time</i>	Typical 15 sec
<i>Long-term drift</i>	The long-term drift is within the specified accuracy.
<i>Influence of ambient temperature</i>	Within the specified accuracy according to OIML R85.
<i>Software reliability</i>	<p>The software used in the 7500 RTG fulfills the requirements of OIML R85. This particularly includes:</p> <ul style="list-style-type: none"> • cyclical test of data consistency • non-volatile memory • segmented data storage <p>The 7500 RTG continuously monitor the compliance with accuracy requirements for custody transfer measurements according to OIML R85. If the accuracy cannot be maintained, a specific alarm is generated on the local display and via the digital communication.</p>

<i>Inventory Control Versions</i>	All device types can be delivered as "Inventory Control Versions" with a reduced accuracy of ± 3 mm (under reference conditions). To these versions, the calibration certificate or custody transfer type approval is NOT attached. The "Inventory Control Versions" can be selected by choosing the option »R« in feature »70« in the order code section »Custody transfer approvals« on page 8.
Operating conditions	
Operating conditions	
<i>Engineering tips</i>	See page 14
Environment	
<i>Ambient temperature range</i>	Ambient temperature for the transmitter: <ul style="list-style-type: none"> • Standard: $-40\text{ °C} \dots +80\text{ °C}$ ($-40\text{ °F} \dots +176\text{ °F}$) • For calibration to regulatory standards: $-25\text{ °C} \dots +60\text{ °C}$ ($-30\text{ °F} \dots +140\text{ °F}$) With $T_u < -20\text{ °C}$ and $T_u > +60\text{ °C}$ the operability of the LC-display is reduced. A weather protection cover should be used for outdoor operation if the instrument is exposed to direct sunlight.
<i>Storage temperature</i>	$-40\text{ °C} \dots +80\text{ °C}$ ($-40\text{ °F} \dots +176\text{ °F}$)
<i>Climate class</i>	DIN EN 60068-2-38 (test Z/AD)
<i>Degree of protection</i>	<ul style="list-style-type: none"> • housing: IP 65, NEMA 4X (open housing: IP20, NEMA 1) • antenna: IP 68 (NEMA 6P)
<i>Vibration resistance</i>	DIN EN 60068-2-64 / IEC 68-2-64: 20...2000 Hz, 5 (m/s ²)/Hz
<i>Cleaning of the antenna</i>	See »Technical Information« TEC028
<i>Electromagnetic compatibility</i>	<ul style="list-style-type: none"> • emissions according to EN 61326; equipment class B • compatibility according to EN 61326; appendix A (industrial area, 10 V/m) and Namur recommendation EMC (NE 21).
Process conditions	
<i>Process temperature range</i>	See »Technical Information« TEC028
<i>Process temperature limits</i>	See »Technical Information« TEC028
<i>Process pressure limits</i>	See »Technical Information« TEC028
<i>Dielectric constant</i>	<ul style="list-style-type: none"> • in a stilling well: $\epsilon_r \geq 1.4$ • in free space: $\epsilon_r \geq 1.9$
<i>Wetted parts</i>	<ul style="list-style-type: none"> • Planar, gas-tight Wetted parts: 1.4435 / HNBR (Hydrated Nitrit Butadien Rubber, resistant to NH₃) or FKM / PTFE glas fiber laminat Note! The planar antenna is not resistant to hot vapor! • Horn adapter for increase of diameter Wetted parts: 1.4435

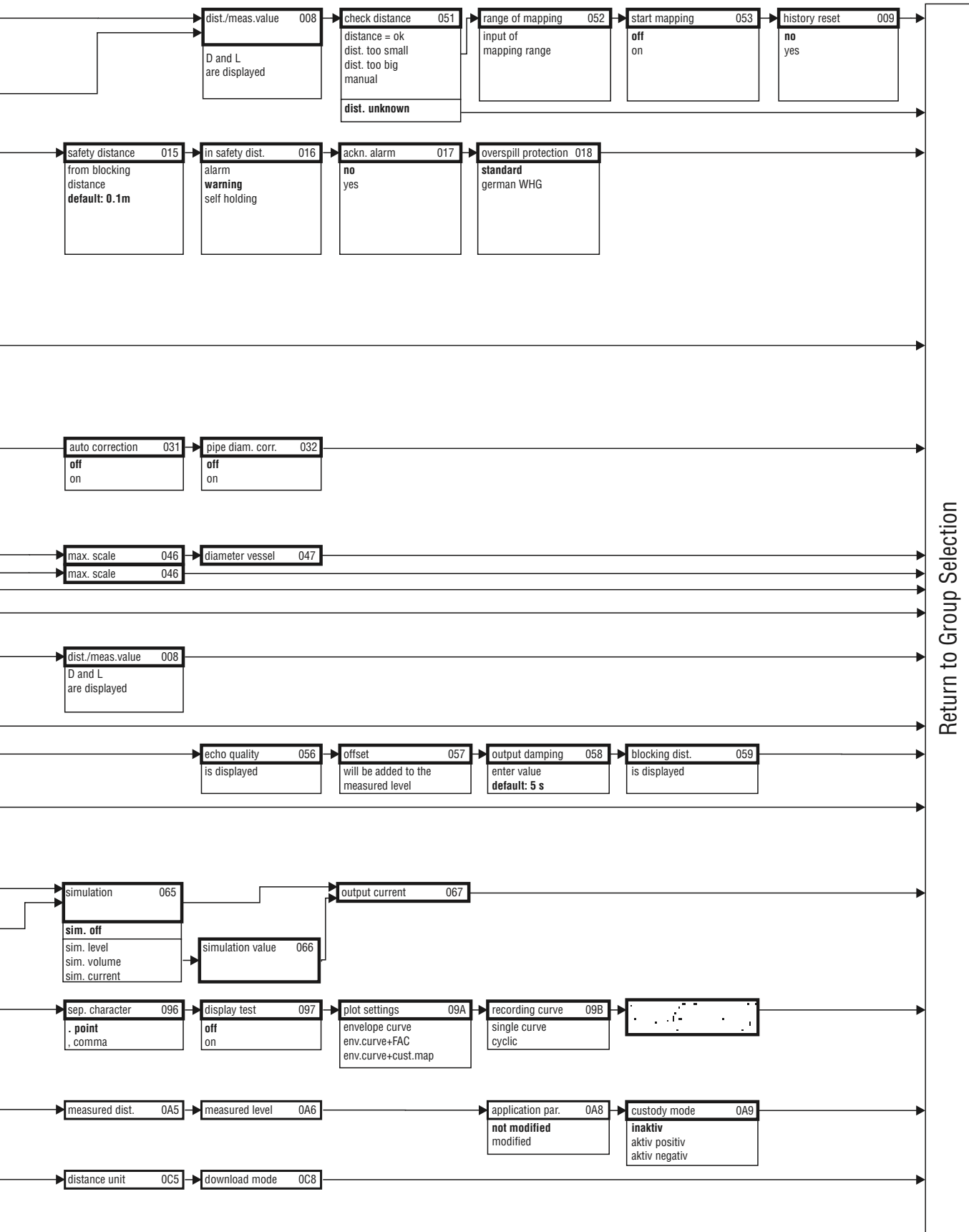
Mechanical construction	
<i>Design, dimensions</i>	See page 13
<i>Weight</i>	Approx 6 kg + weight of flange
<i>Material</i>	See page 8
<i>Process connection</i>	see page 8 All process connections dispose of a gas-tight glass feed-through to prevent any gas leakage to the inside of the housing.
Human interface	
<i>Operation concept</i>	See page 31
<i>Display</i>	See page 31
Certificates and approvals	
<i>CE approval</i>	The measuring system meets the legal requirements of the EC-guidelines. Varec confirms the instrument passing the required tests by attaching the CE-mark.
<i>RF approvals</i>	R&TTE 1999/5/EG, FCC CRF 47, part 15
<i>Overspill protection</i>	PTB , NMI and many other national approvals
<i>External standards and guidelines</i>	<p>EN 60529 Protection class of housing (IP-code)</p> <p>EN 61010 Safety regulations for electrical devices for measurement, control, regulation and laboratory use.</p> <p>EN 61326 Emissions (equipment class B), compatibility (appendix A - industrial area)</p> <p>NAMUR Standards committee for measurement and control in the chemical industry</p> <p>API (American Petroleum Institute) Particularly "Manual of Petroleum Measurement Standards".</p> <p>OIML R85 (Organisation Internationale de Metrologie Legale)</p>
<i>Ex approval</i>	<p>XA 081F-A Installation 7500 RTG (T12 / EEx ia IIC T6...T1) PTB 00 ATEX 2067 X, Equipment marking: (II 1/2 G)</p>
Ordering Information	
	The Varec service organisation can provide detailed ordering information an information on the order codes on request.
Accessories	
	see page 75
Supplementary Documentation	
<i>Supplementary Documentation</i>	<ul style="list-style-type: none"> • System Information • Technical Information • Operating Instructions

11 Appendix

11.1 Operating menu HART (Display modul), ToF Tool



Note! The default values of the parameters are typed in boldface.



Return to Group Selection

11.2 Operating matrix HART / Commuwin II

Operating Matrix HART / COMMUN II

Function group	V-CWII	H0	H1	H2	H3	H4	H5	H6	H7	H8	H9
00 basic setup	V0	measured value	output on alarm	tank shape	medium property	process cond.	empty calibr.	full calibr.	pipe diameter		
01 safety settings	V1	output on alarm	output on alarm	outp. echo loss	ramp %span/min	delay time	safety distance	in safety dist.	ackn. alarm	overspill protection	
03 mounting calibr.	V2	tank gauging	auto correction	pipe diam. corr.	dip table mode	dip table	dip table	dip table handl.	dip table state		
04 linearisation	V3	level/ullage	linearisation	customer unit	table no.	input level	input volume	max. scale	diameter vessel		
05 extended calibr.	V4		check distance	range of mapping	start mapping	pres. Map dist	cust. Tank map	echo quality	offset	output damping	blocking dist.
06 output	V5	commun. Address	no. Of preambels	low output limit	fixed current	fixed current	simulation	simulation value	output current		
09 display	V6			language	back to home	format display	no. of decimals	sep. character			
0D service	V7										
0A diagnostics	V9	present error	previous error	clear last error	reset	unlock parameter	measured dist.	measured level		application par.	custody mode
0C system parameter	VA	tag no.		protocol+sw-no.	software no.	serial no.	distance unit			download mode	

11.3 Description of functions

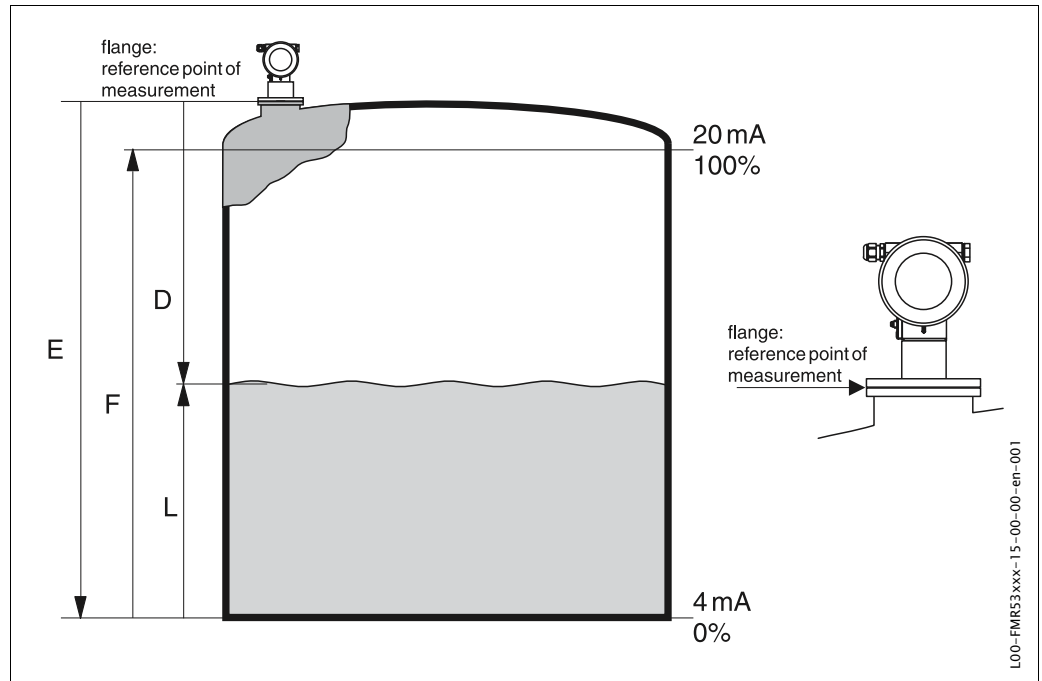
Note!

A detailed description of the function groups, functions and parameters is given in the the 7500 RTG "Service manual and description of instrument functions".

11.4 Function and system design

11.4.1 Measuring principle

The 7500 RTG is a "downward-looking" measuring system, operating based on the time-of-flight method. It measures the distance from the reference point (process connection) to the product surface. Radar impulses are emitted by an antenna, reflected off the product surface and received again by the radar system.



Input

The reflected radar impulses are received by the antenna and transmitted into the electronics. A microprocessor evaluates the signal and identifies the level echo caused by the reflection of the radar impulse at the product surface. The unambiguous signal identification is accomplished by the PulseMaster® software based on many years of experience with time-of-flight technology. The mm-accuracy of the 7500 RTG is achieved with the patented algorithms of the PhaseMaster® software.

The distance D to the product surface is proportional to the travel time t of the impulse:

$$D = c \cdot t/2,$$

with c being the speed of light.

Based on the known empty distance E , the level L is calculated:

$$L = E - D$$

Reference point for "E" is the lower surface of the process connection.

The 7500 RTG is equipped with functions to suppress interference echoes. The user can activate these functions. They ensure that interference echoes (e.g. from edges and weld seams) are not interpreted as level echo.

Output

The 7500 RTG is commissioned by entering an empty distance E (=zero), a full distance F (=span), and an application parameter. The application parameter automatically adapts the instrument to the measuring conditions. The data points "E" and "F" correspond with 4mA and 20mA for instruments with current output. They correspond with 0 % and 100% for digital outputs and the display module.

A linearization with max. 32 points, based on a table entered either manually or semi-automatically, can be activated locally or remotely. This function provides a measurement in engineering units and a linear output signal for spheres, horizontal cylindrical tanks, and vessels with conical outlet.

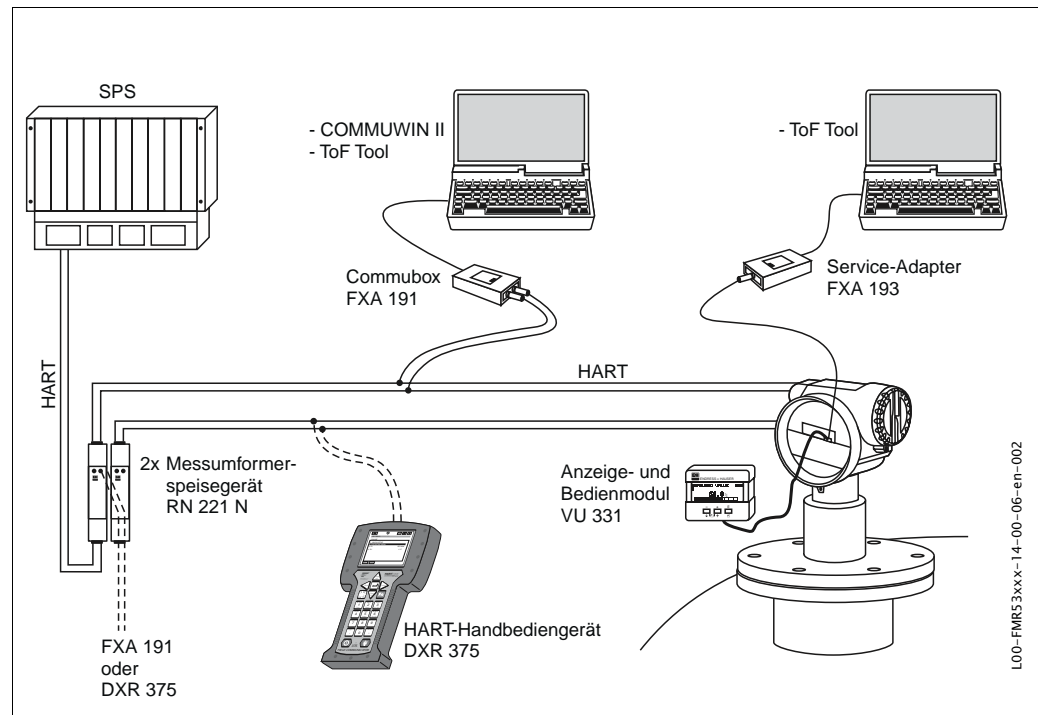
11.4.2 Equipment architecture

Stand-alone

The 7500 RTG can be used for measurement in a stilling well as well as in free space. The different instrument versions are applied as follows:

- The 7532 RTG with planar antenna is the preferred device in stilling wells ≥ 150 mm.
- The 7530 RTG with horn antenna can be used in stilling wells with a diameter < 150 mm. However, for these diameters no custody transfer approval is available.
- The 7533 RTG with parabolic antenna is preferred for free-space measurements. The 7530 RTG with horn antenna can be used as an alternative for small nozzle diameters.
- The 7531 RTG with rod antenna (PTFE) should be used for measurements of highly aggressive media (e.g. sulphur).
- The instruments are equipped with a passive 4...20 mA output with HART protocol.

The complete measuring system consists of:



On-site operation:

- with display and operating module VU 331,
- with a Personal Computer, FXA 193 and the operating software ToF Tool.
The ToF Tool is a graphical operating software for instruments from Varec that operate based on the time-of-flight principle (radar, ultrasonic, guided micro-impulse). It assists with commissioning, securing data, troubleshooting, and documentation of the measuring point.

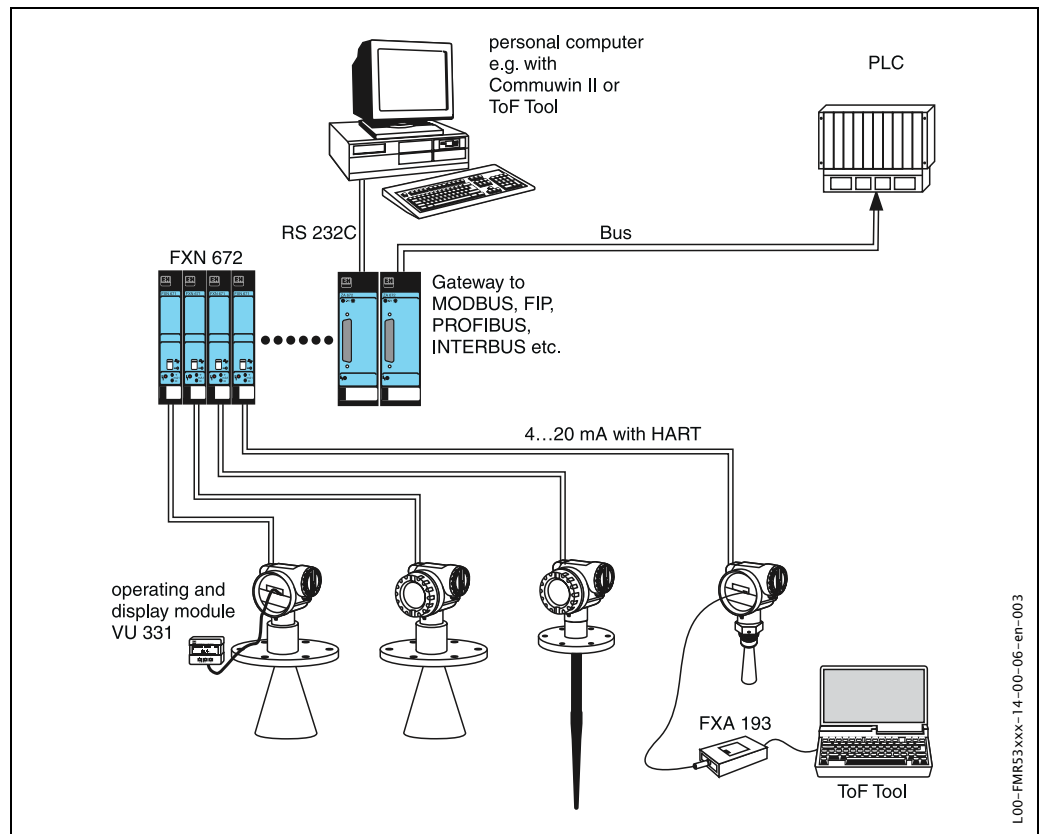
Remote operation:

- with HART handheld DXR 35,
- with a Personal Computer, Commubox FXA 191 and the operating software COMMUWIN II respectively ToF Tool.
- With a Personal Computer, TSM (Tank Side Monitor) and the operating software FuelsManager.

System integration via Rackbus

Multiple 7500 RTG (or other instruments) can be connected to a higher-level bus system via a Gateway ZA:

- Every HART transmitter via one interface module FXN 672 each.
- Gateways are available for MODBUS, FIP, PROFIBUS, INTERBUS etc.
- Both on-site as well as remote operation are possible.

**Integration into the Asset Management System**

The HART interface allows the integration into the AMS® (Asset Management System) from Fisher-Rosemount.

11.4.3 Custody transfer mode

7500 RTG is a weight and measure approved level transmitter. Either the innage or the ullage can be selected as the custody transfer variable.

The selected variable is the basis for the subsequent calculation of the current amount of product in a tank, along with other measured variables such as (average) temperature and pressure.

This opens up numerous application options in custody transfer:

- Quantity calculation of mineral oils
- Quantity calculation of alcohols

11.4.4 Weight and measure approval, Standards Authorities approval, Compulsory reapproval

The *type approvals for custody transfer* issued by the PTB and NMI, a copy of which is enclosed with every device, prove the fundamental suitability of the various types for custody transfer.

In addition to this, the *accuracy* of every single device is documented using a calibration certificate, which is issued in the factory after the device has been tested on a reference test rig.

On request, a separate *initial verification* of the devices can be carried out with a National Standards Authorities inspector present, who issues a *preliminary test certificate* for every device. In the initial verification, the device is tested to ensure that it complies with the *limit of error in legal metrology*, which lies at $\pm 2\text{mm}$ for radar measuring devices in Germany.

Essentially, this proves that the devices are *weight and measure approved*. The devices must not, however, be used in custody transfer mode straight away.

The measuring device is not approved until after the *approval after installation* by the Standards Authorities. For this, the device's level measurement is compared with the tank gauging by a National Standards Authorities inspector using manual dips (also "initial verification"). As a rule, a quiescent tank gauging is dipped by hand three times in a row and then compared with the value displayed by the level radar. Depending on national regulations, the transfer error limit, calculated as the arithmetic mean of the absolute deviations of all three measurements, must not exceed double the limit of error in legal metrology (compare, for example, the German "Eichordnung" or the American "API 3.1 B", in which the necessary procedures are also defined).

Depending on national regulations, this test is repeated with various tank gaugings. Using linearization tables to compensate any non-linearities that occur in measurement is permitted. For this, the 7500 RTG level radar offers a special dip table, compare "Mounting calibration with VU 331" on page 57.

After the measurement has been approved by an inspector, he seals the level radar at the stamp position and thereby also secures the programming status of the device.

Those operating an approved level transmitter are obligated to obtain *reapproval* in accordance with the applicable national regulations from the Standards Authorities.

11.4.5 Particularities in "approved" operation

The 7500 RTG level radar is set to custody transfer mode after commissioning using a custody locking switch (see page 36). The position of the custody locking switch is secured and sealed using the sealing pin.

During custody transfer measurement, all custody transfer-relevant functions for operation are automatically locked, so that the device software can not be used, either via local operation or via digital communication settings. This locked status is displayed by the key symbol (🔒).

7500 RTG radar devices continuously monitor the compliance with accuracy requirements for custody transfer measurements according to OIML R85. If, for example, the accuracy cannot be maintained due to quick surface movements, this is reported via a separate alarm in the local display (displays "#" symbol) and via digital communication.

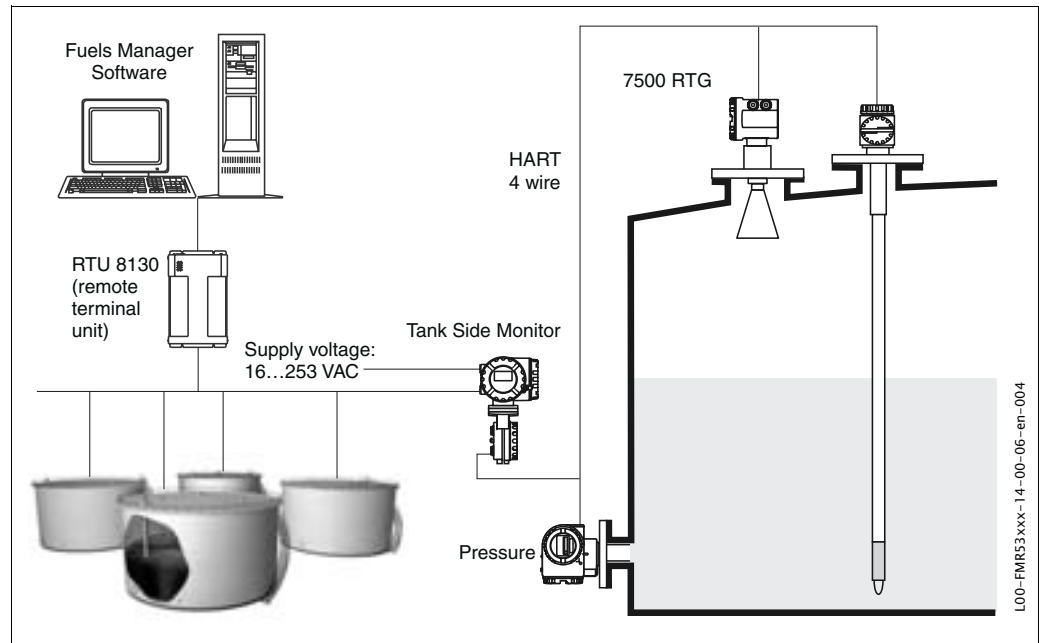
11.4.6 Definition of terms

For definitions and procedures please refer to the following documents:





- Manual of Petroleum Measurement Standards, Chapter 3 – Tank Gauging, Section 1.B – Standard Practice for Level Measurement of Liquid Hydrocarbons in Stationary Tanks by Automatic Tank Gauging, American Petroleum Institute, second edition, 2001
- OIML R 85, Organisation Internationale de Métrologie Légale, International Recommendation R 85, edition 1998 (E)

11.4.7 Integrated on tank gauging system

The Varec Tank Side Monitor 4590 provides integrated communications for sites with multiple tanks, each with one or more sensors on the tank, such as radar, spot or average temperature, capacitive probe for water detection and/or pressure sensors. Multiple protocols out of the Tank Side Monitor guarantee connectivity to nearly any of the existing industry standard tank gauging protocols. Optional connectivity of analog 4...20 mA sensors, digital I/O and analog output simplify full tank sensor integration. Use of the proven concept of the intrinsically safe HART bus for all on-tank sensors yields extremely low wiring costs, while at the same time providing maximum safety, reliability and data availability.



This product may be protected by at least one of the following patents.

- US 5,387,918  EP 0 535 196
- US 5,689,265  EP 0 626 063
- US 5,659,321  EP 0 670 048
- US 5,614,911  EP 0 676 037
- US 5,594,449 
- US 6,047,598
- US 5,880,698
- US 5,926,152
- US 5,969,666
- US 5,948,979
- US 6,054,946
- US 6,087,978
- US 6,014,100

Further patents are pending.

Index

A

Accessories	75
Alarm	40
Antenna extension	75
Antenna size	13
Approval after installation	100
Auto-correction	57

B

Basic Setup	46
Basic Setup VU 331	49
Blocking distance	16
Bypass	15

C

Cable entry	28
Calibration to regulatory standards disturbed	35
CE approval	90
CE mark	10
Check distance	54
Cleaning agents	73
Commissioning	45
Communication symbol	35
Commuwin II	43, 75
Commuwin II-Operating Programm	43
Contrast settings	36
Current consumption	28
Custody locking switch	34, 36
Custody mode	59
Customer unit	49

D

Declaration of conformity	10
Degree of protection	30
Diameter	17
Dielectric constant	50
Dimensions	13
Dip Table Mode	61
Dip table status	61
Dip value	62
Display	34
Distance	46, 53

E

Electrical symbols	6
Empty calibration	46, 52
Envelope curve	65
Error messages	40

F

Foam	14
Foam surface	14
Full calibration	46, 52
Function groups	33

Functions	33
-----------------	----

G

Green LED	35
Group selection	31

H

Handheld unit DXR 275	41
HART	28–29, 41
Housing T12	86

I

Initial verification	100
Installation in stilling well	11
Installation in tank (free space)	11
Interference echo	54
Interference echo mapping	54–55, 68

K

Key assignment	36
----------------------	----

L

Level	46, 53
Liquid crystal display (LCD)	34
Load	28
Lock	37

M

Mapping	54–55
Marker at instrument flange	17
Maximum measured error	88
Measure value actualisation	48
Measured value	49
Measured value display	31
Measuring principle	87
Measuring range	14
Medium conditions	50
Minimum level	52
Modification nameplate	85
Mounting	11
Mounting calibration	57, 70
Mounting kit	17

N

Nameplate	7
Navigation	36
No. of decimals	49
Notes on safety conventions and symbols	6

O

Operating menu	33
Operation	31, 37
Ordering structure	8

P

- Parameter 31
- Phase evaluation 51, 57, 60
- Pipe diam. corr. 58
- Pipe diameter 53
- Pivoting element. 24
- Post-installation check 24
- Power consumption 28
- Power supply fails 48
- Process conditions 51
- Product class 15

Q

- Quick wiring guide 25

R

- Range of mapping 55
- Reapproval. 100
- Recommendations for the stilling well 17
- Red LED. 35
- Reference point of measuring 46
- Replacement 73
- Reset 39
- Reset customer parameters 39
- Return 86
- RF approvals 90

S

- Safety conventions. 6
- Sample hatch 23
- Scope of delivery 10
- Sealing 34
- Select the language 45
- Selection menu 31
- Service adapter FXA 193 75
- Slot width 17
- Slots 17
- Smallest possible measuring range 14
- Software history 86
- Spare parts 83
- Stilling well 15, 53
- Supplies 29
- Supply voltage 28
- Switching on the measuring device 45

T

- Tank Gauging 57
- Tank shape 49, 67
- Technical Data 87
- Terminal compartment 28
- ToF Tool 41, 66, 69–70, 91
- Trademarks 10
- Trouble-shooting 77
- Trouble-shooting instructions 77
- Turn housing 11, 19

U

- Unlock 36

- Unlock parameter 37–38

W

- Warning 40
- Weather protection cover 75
- Weight and measure approved 100
- Weld seam 17
- Wiring 25

Notes

Your official representative

Varec®



www.varec.com